

# TX-29AD70DP Operating Instruction

---



# Panasonic



## TX-29AD70DP

(U.K. Standard)



**100Hz**  
*SUPER DIGITAL SCAN*

King of Pictures  
**GAOO**

**Super**  
**3DBASS**

# Quintrix



Please read these instructions completely before use and retain them for future reference.

Dolby, Pro Logic and the  are trademarks of Dolby Laboratories.  
Manufactured under license from Dolby Laboratories Licensing Corporation.

Dear Panasonic Customer,  
Welcome to the Panasonic family of customers. We hope that you have many years of enjoyment from your new colour television. This is a very advanced television, however, the Quick Start Guide will tell you how to have the TV operating quickly; you can then read the following pages to fully utilise the advanced features.



This television has a low power consumption making it very cost effective to run.  
To this end, the standby power consumption is merely 1 watt.

---

## CONTENTS

---

Warnings and Precautions .....	3	Dolby Pro Logic Surround Menu .....	25
Accessories .....	4	Pro Logic mode .....	26
Fitting Remote Control Batteries .....	4	Simulated mode .....	27
Quick Start Guide .....	5	Speaker level setup .....	27
Basic Controls .....	8	Teletext Operation .....	28
Using the On Screen Menus .....	9	VCR and Satellite Receiver Installation .....	30
Aspect Control .....	10	VCR Control .....	31
Still Picture Controls .....	11	Audio / Video Connections .....	32
Main Menu .....	12	Via the front AV3 4 pin S–Video, Audio / Video (RCA) and Headphone Sockets .....	32
Sound Menu .....	13	SCART and S–Video Terminal Information .....	32
Setup Menu .....	14	Via the rear AV1 / AV2(S) 21 Pin (SCART) and RCA Audio Out terminals .....	33
Tuning Menu .....	15	Using external amplifiers and speakers .....	34
Tuning Menu – Programme edit .....	16	Trouble–shooting .....	35
Tuning Menu – Auto Setup .....	21	For your guidance .....	36
Tuning Menu – Manual tuning .....	22	Specifications .....	36
Tuning Menu – Shipping Condition .....	23		
AV Select and Setup .....	24		

# WARNINGS and PRECAUTIONS

- This TV is designed to operate on A.C. 220 – 240V, 50Hz.
- This TV is capable of receiving the following transmission standard, PAL I.
- To prevent damage which might result in electric shock or fire, do not expose this TV set to rain or excessive moisture.
- **WARNING : HIGH VOLTAGE !!!**  
Do not remove the rear cover as live parts are accessible when it is removed. There are no user serviceable parts inside.
- Avoid exposing the TV set to direct sunlight and other sources of heat.
- Remove the mains plug from the wall socket when the TV set is not used for a prolonged period of time.



- **CABINET AND PICTURE TUBE CARE**

Remove the mains plug from the wall socket. The cabinet and picture tube can be cleaned with a soft cloth moistened with mild detergent and water. Do not use solutions containing benzol or petroleum. TV sets can produce static electricity, care must be taken whenever touching the TV screen.

- Adequate ventilation is essential to prevent failure of electrical components. We recommend that a gap of at least 5cm is left all around this TV even when it is placed inside a cabinet or between shelves.

## FOR YOUR SAFETY PLEASE READ THE FOLLOWING TEXT CAREFULLY

This appliance is supplied with a fitted three pin mains plug for your safety and convenience. A 5 amp fuse is fitted in this plug. If the fuse is replaced then the replacement fuse must be 5 amp rated and should be approved by ASTA or BSI to BS1362.

Check for the ASTA mark  or the BSI mark  on the body of the fuse.

If the fitted plug has a removable fuse cover you must ensure that it is refitted when the fuse is replaced. If you lose the fuse cover the plug must not be used until a replacement cover is obtained. Replacement fuse covers can be purchased through your local Panasonic dealer.

**The plug fitted to this appliance incorporates a mains filter circuit. If this is removed or replaced with a non-filtered plug this television will no longer meet the European standards for Electromagnetic Compatibility (EMC). If the fitted plug is unsuitable for the socket outlet in your home an appropriate adapter should be used.**

**Nonetheless, if the fitted plug is replaced, the fuse should be taken out and the cut-off plug disposed of safely. There is danger of severe electrical shock if the cut off plug is inserted into any 13 amp. socket.**

If a new plug is to be fitted please observe the wiring code as shown below.  
If in any doubt please consult a qualified electrician.

### How to replace the fuse (for plug type shown in example 1) :

Lift out the removable fuse compartment with a screwdriver and replace the fuse, then refit securely into the mains plug (See example 1).

### How to replace the fuse (for plug type shown in example 2) :

Lift open the fuse compartment, in the mains plug, with a screwdriver, and replace the fuse, then press the fuse cover down securely. (See example 2).

Example 1.

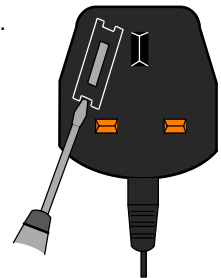

Example 2.

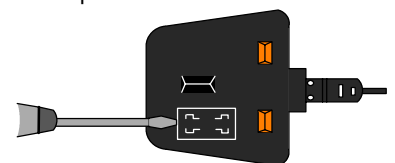

**IMPORTANT :-** The wires in the mains lead of this appliance are coloured in accordance with the following code :-

BLUE : NEUTRAL

BROWN : LIVE

As the colours of the wires in the mains lead of this appliance may not correspond to the markings identifying the terminals in your plug, proceed as follows :-

1. The **BLUE** wire must be connected to the terminal marked 'N' or coloured black.
2. The **BROWN** wire must be connected to the terminal marked 'L' or coloured red.

**IMPORTANT NOTE :** Under no circumstances should either of these wires be connected to the Earth terminal of the three pin plug, marked with the letter 'E' or the earth symbol. 

# ACCESSORIES

## Check that you have the accessories and items shown



Operating Instruction book

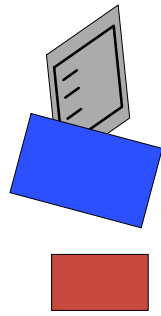

TV Guarantee

CRT Guarantee

Questionnaire

Remote Control Transmitter  
EUR 51926

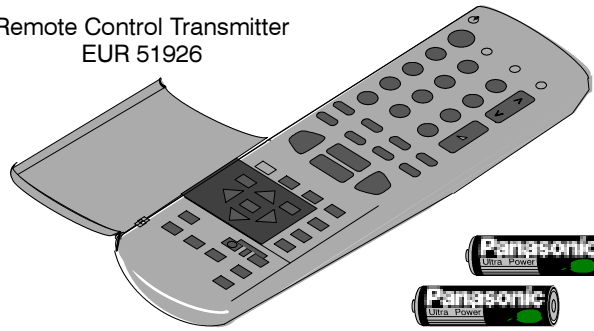

Batteries for the  
Remote Control Transmitter.  
(2 x R6 (UM3) size)

### TS-350DP

Consisting of :  
VS-AD70DP Video cabinet  
1 x Centre speaker  
2 x Rear speakers  
2 x Speaker cables

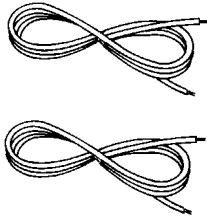

Video cabinet

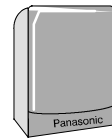
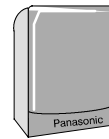

## FITTING REMOTE CONTROL BATTERIES

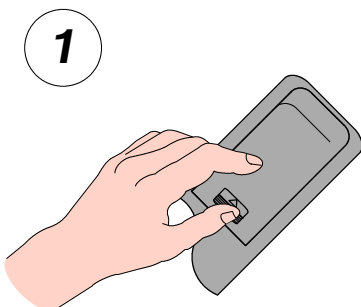

Slide off the battery cover

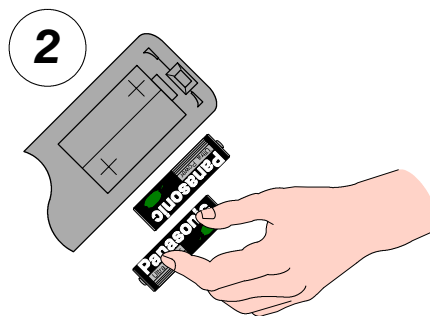

Insert batteries – note correct polarity

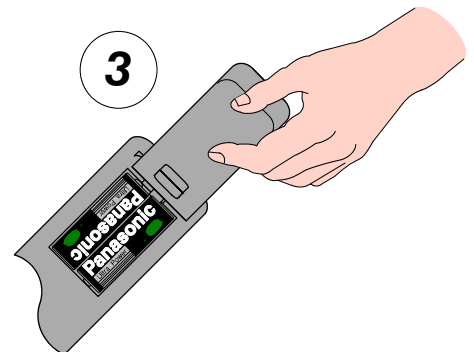

Replace the cover

### Notes:

- Make sure that the batteries are fitted the correct way round.
- Do not mix old batteries with new batteries. Remove old, exhausted batteries immediately.
- Do not mix different battery types, i.e. Alkaline and Manganese. Do not use rechargeable (Ni-Cad) batteries.

## 1 . 2 . 3 . . . . .

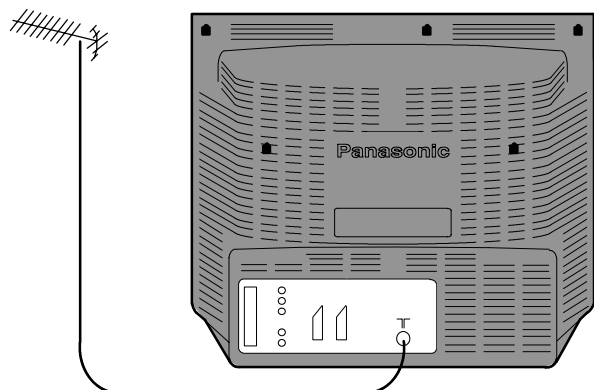

1

TV only

Connect Aerial co-axial cable direct to TV RF IN socket.

OR

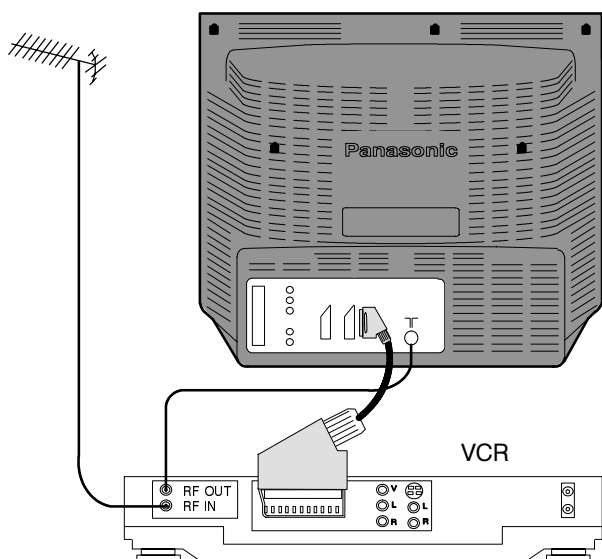

USING A VCR

Connect Aerial co-axial cable to RF Input socket of VCR and a RF coaxial cable from VCR RF Out socket to TV RF IN socket.

The VCR can also be connected to the TV using a SCART to SCART lead if you are using a stereo VCR. Use the AV1 21 pin terminal for a VCR. To connect an S-Video VCR use the AV2S 21 pin terminal.

Further details of Audio/ Video connections can be found on pages 32 and 33.

OR

USING A VCR AND SATELLITE RECEIVER

Connect Aerial co-axial cable to RF Input socket of Satellite Receiver. An RF coaxial cable connects from Satellite Receiver RF Out socket to VCR RF IN socket.

A further Coaxial cable connects from the VCR RF OUT socket to the TV RF IN socket.

The Satellite Receiver and VCR can also be linked by SCART to SCART lead if you are using a stereo VCR.

Further information for VCR and Satellite Receiver installation with this TV can be found on page 30.

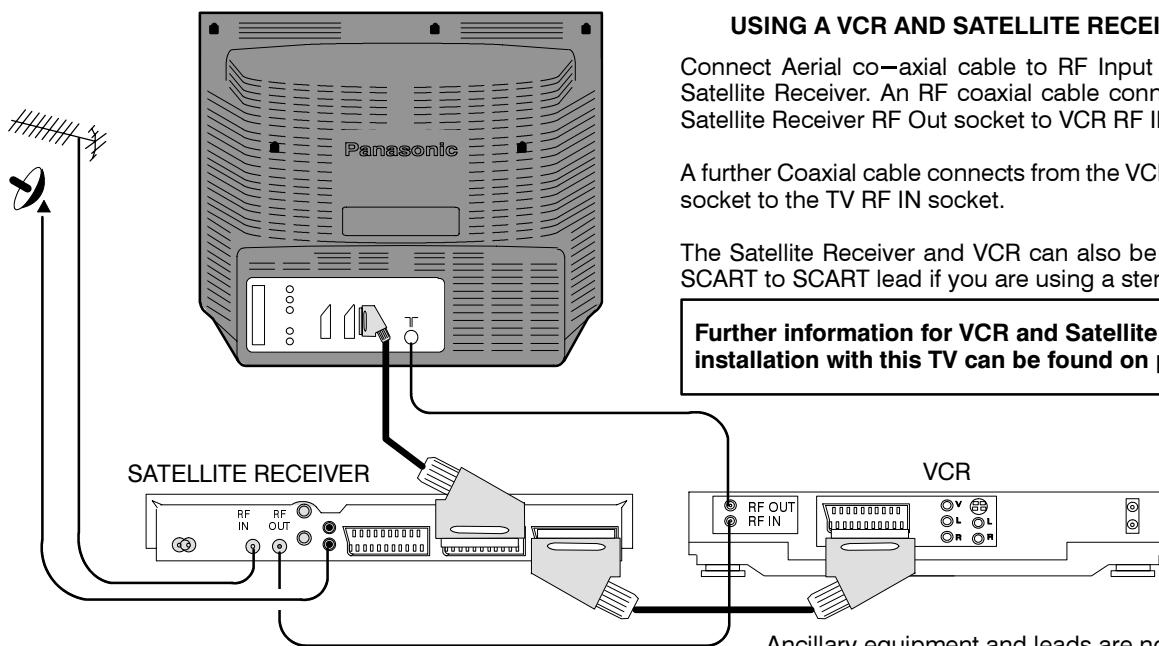

Ancillary equipment and leads are not supplied.

# QUICK START GUIDE

## 2 Connect the speakers with the TV switched off

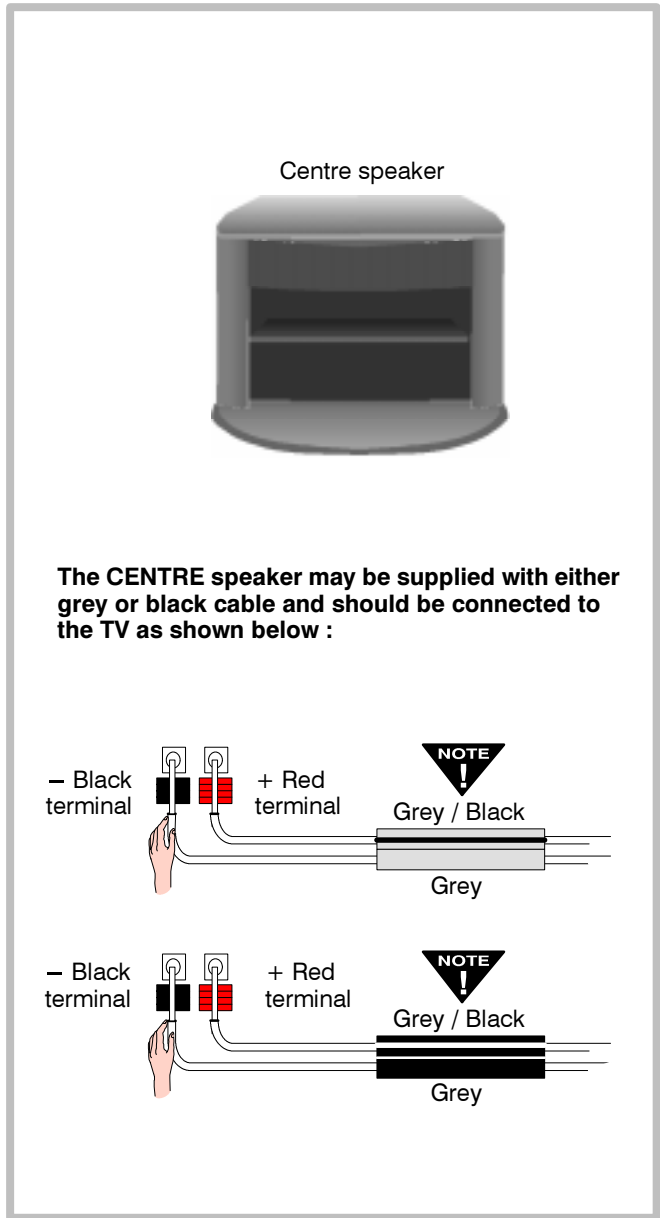
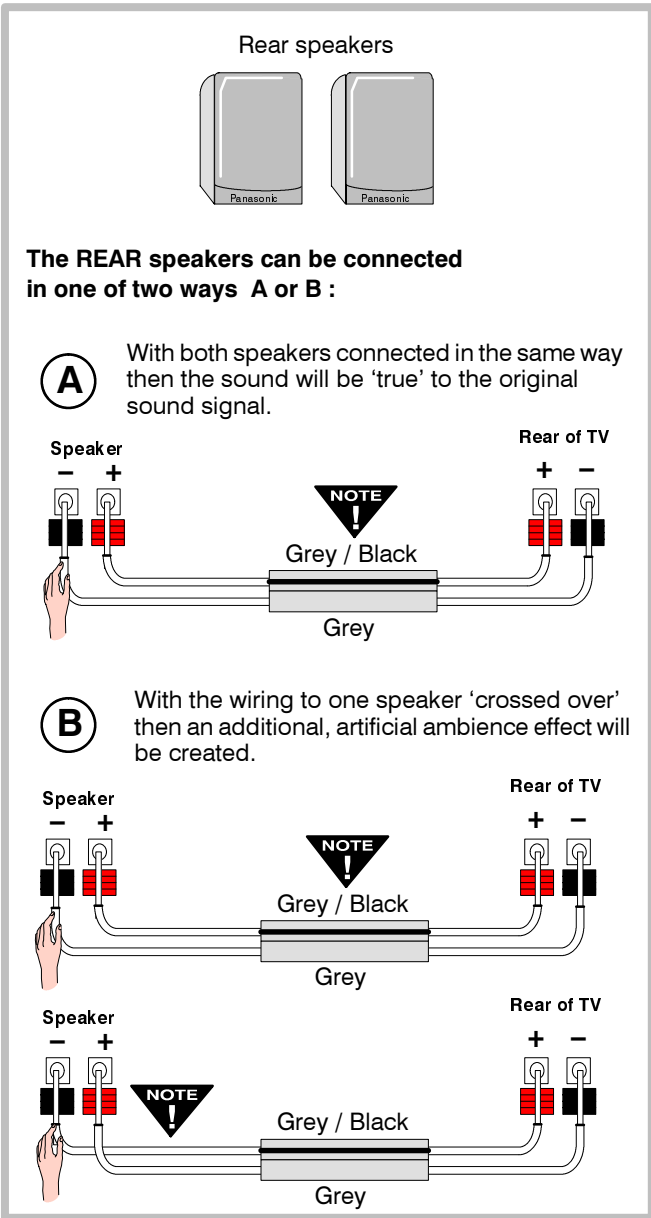
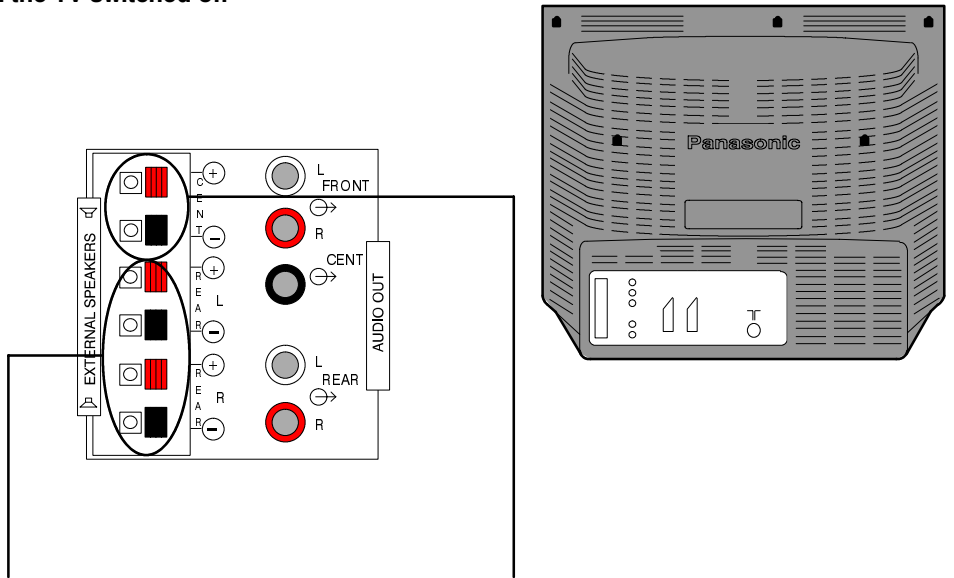
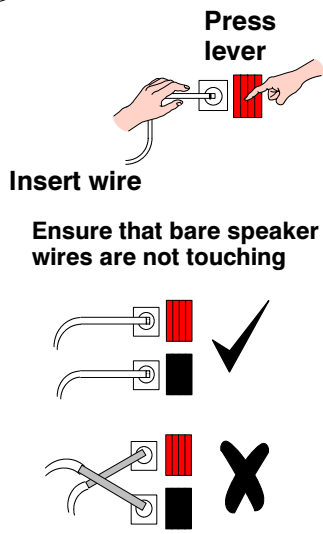

# QUICK START GUIDE

**3** Position the speakers

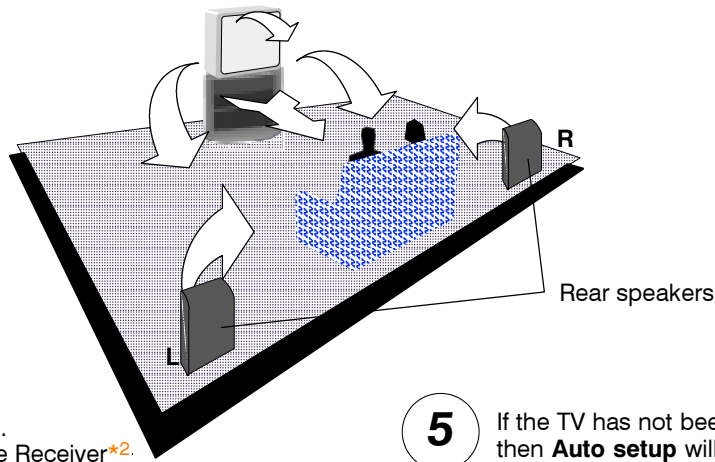

**4** Switch ON your VCR \*1.  
Switch ON your Satellite Receiver\*2.  
Plug the TV into mains socket and switch on .  
Programmes will appear immediately if your dealer has programmed the TV for you.

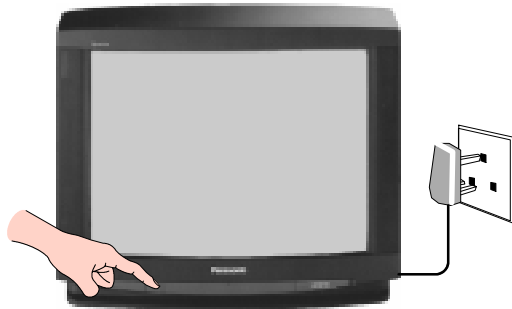

**5** If the TV has not been programmed for you then **Auto setup** will begin. TV stations will be located, sorted into order and stored ready for use\*3.

Switch the VCR Test Signal 'off'\*4 .

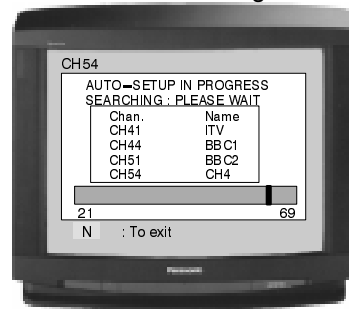

**... READY TO GO!**

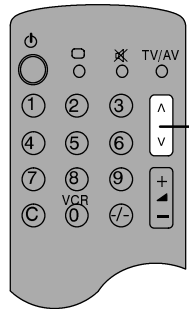

Change Channel

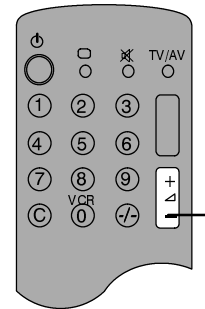

Adjust Volume

- \*1. If your VCR Test Signal appears as a programme position it can be deleted using the Programme Edit menu. We recommend that you have the VCR's test signal 'on' – refer to your VCR instruction book to locate the VCR Test Signal switch (usually on the rear of the VCR).
- \*2. The Satellite Receiver must be tuned to either SKY ONE or SKY NEWS before starting Auto Setup. When Auto Setup has finished, the satellite position that has been stored will be listed as 'SAT'.
- \*3. The sorting order depends upon the TV signal, the broadcasting system, and reception conditions. If the order is not to your preference it can be rearranged. Refer to the Programme Edit menu – see page 16 for details.

Prog. Position	All channels	No CH5	No CH5 / S4C	No CH4 / CH5	No S4C	No CH4 / S4C	No CH4 / S4C / CH5
1	BBC1	BBC1	BBC1	BBC1	BBC1	BBC1	BBC1
2	BBC2	BBC2	BBC2	BBC2	BBC2	BBC2	BBC2
3	ITV	ITV	ITV	ITV	ITV	ITV	ITV
4	CH4	CH4	CH4	S4C	CH4	CH5	SAT
5	S4C	S4C	SAT	SAT	CH5	SAT	●
6	CH5	SAT	●	●	SAT	●	●
7	SAT	●	●	●	●	●	●

Note :  
● The next available channel will appear, if no other stations are available then the Programme position will remain unused.

- \*4. **IT IS IMPORTANT THAT** you use only programme position '0' for your VCR. If your VCR does not appear to operate on programme position '0' (the VCR position), refer to page 17 or 30 for guidance.



# BASIC CONTROLS

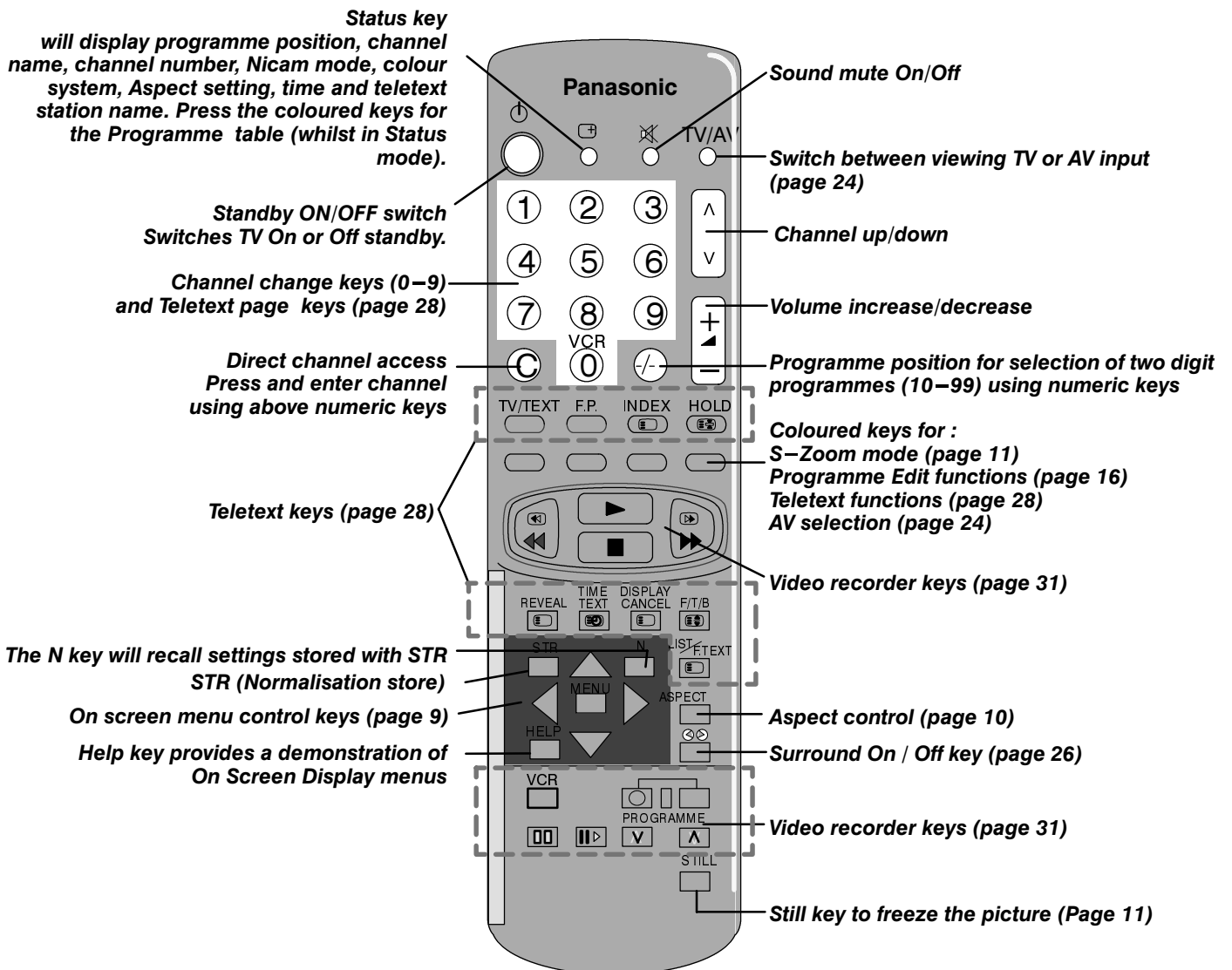
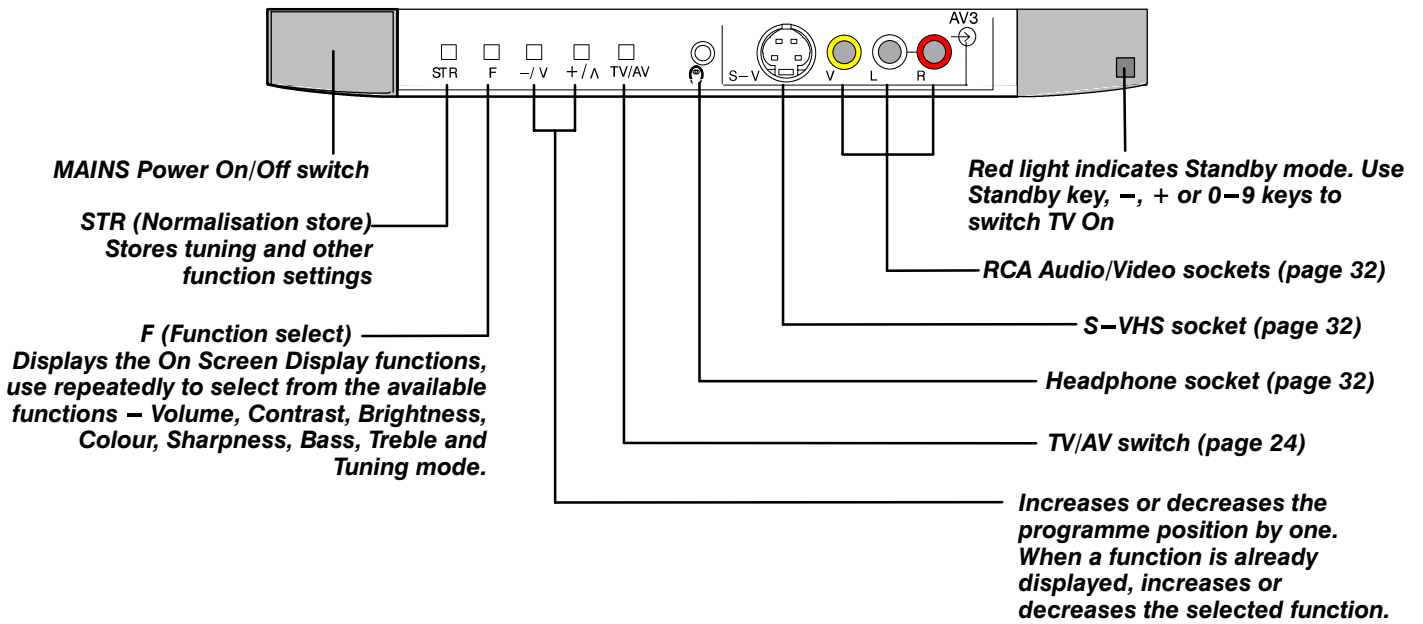

# USING THE ON SCREEN MENUS

This TV has a comprehensive system of On Screen Display menus to access adjustments and options.

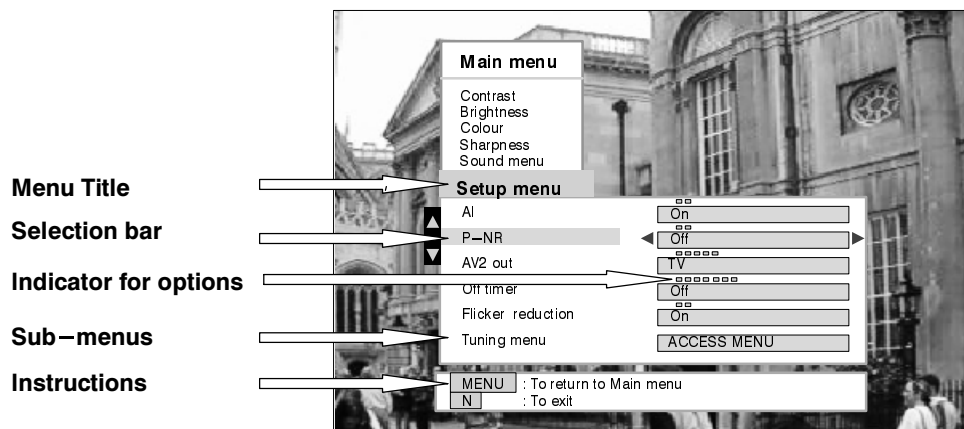

The following remote control keys are used to access and adjust settings for the On Screen Display menus.

Some selections, for example, **Contrast, Brightness, Colour** and **Sharpness** will allow you to increase or decrease their level.

Some selections, for example **Off timer**, allow a choice to be made.

Some selections, for example **Tuning menu**, will lead to a further menu.

The **'MENU'** key is used to open the Main menu and also to return to either the Main menu or a previous menu.

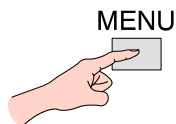

The **▲▼** keys are used to move the cursor up or down the menus.

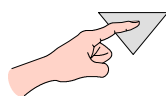

The **◀▶** keys are used to access menus, adjust levels or to select from a range of options.

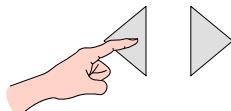

The **'STR'** key is used to store settings after your adjustment or choice has been made.

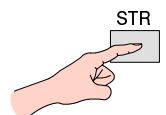

The **'N'** key is used to leave the menu system and return to the normal viewing screen.

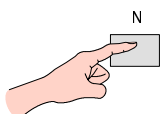

The **'HELP'** key will run a demonstration of the menus available.

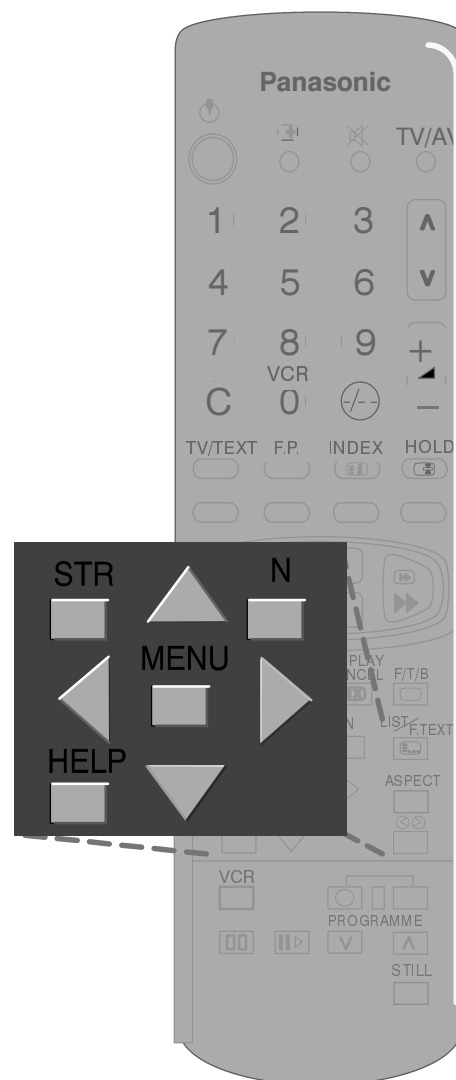
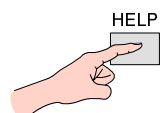

# ASPECT CONTROLS

---



AUTO

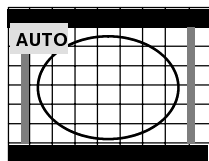

16:9

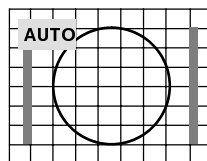

4:3

Selecting **AUTO** mode of this TV will automatically cause the TV to display any incoming picture at its correct format, i.e. 16:9 or 4:3.

---

4:3

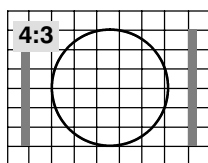

**4:3** will display a 4:3 picture at its standard 4:3 size and can be selected if you wish to view in this format.

---

16:9

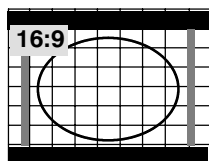

**16:9** will display a 16:9 picture at its standard 16:9 size and can be selected if you wish to view in this format.

You may notice small coloured lines at the top of the viewable picture. This is quite normal and is not a defect of the set.

---

# ASPECT CONTROLS

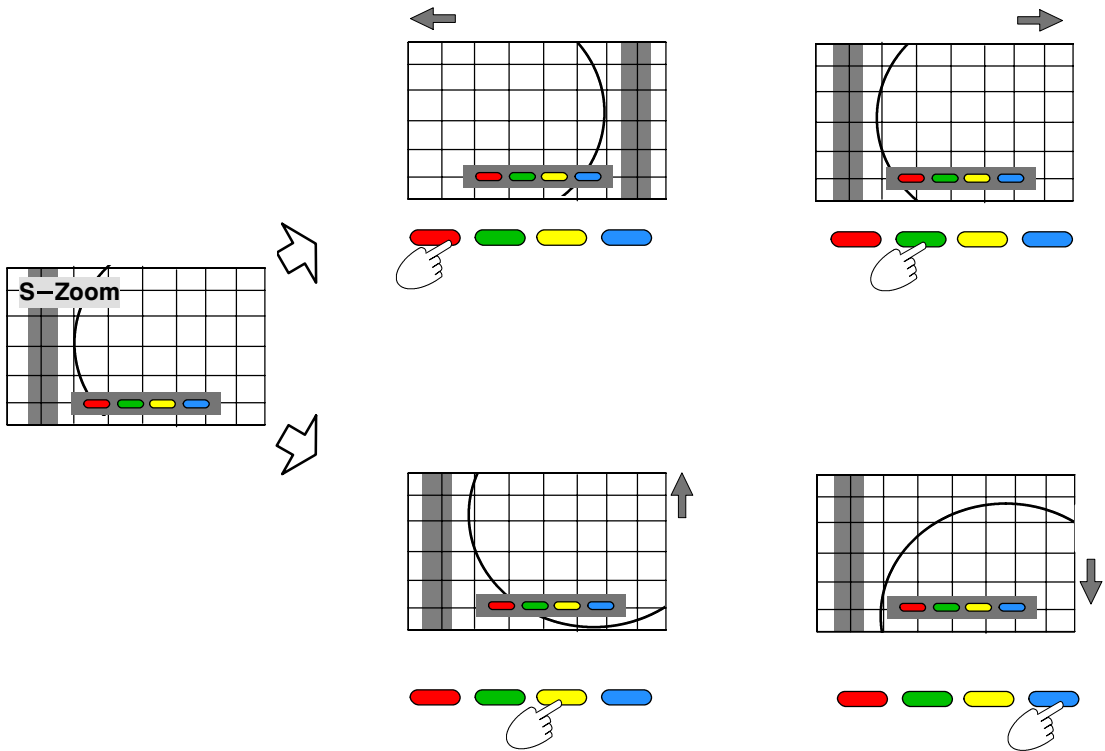
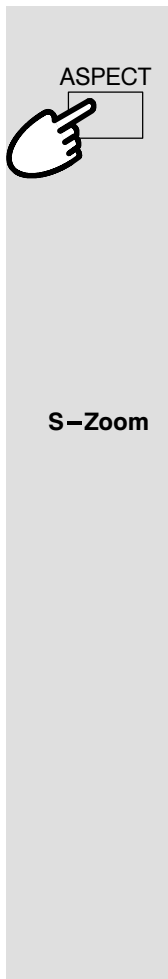

In **S-Zoom** mode the red and green keys will allow you to move the picture horizontally. The yellow and blue keys will allow you to move the picture vertically.

**NOTE:**

- The on screen selector keys that appear for some aspect functions will clear after a few seconds. If you subsequently wish to select an operation then press the Aspect key once more for the keys to reappear.
- A correct 16:9 picture format is only possible when a 16:9 signal is received through the 21 pin terminals. It is possible to switch a normal 4:3 signal into 16:9 mode, but this is for effect only and does not accurately represent the 16:9 picture format.

# STILL PICTURE CONTROLS

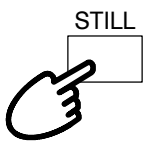

The STILL key allows you to freeze the picture at any time.

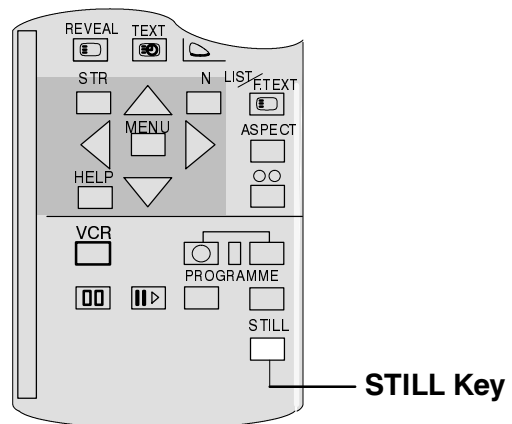

# MAIN MENU

All menus start from the Main menu (except AV select and Tuning procedure (Front panel)). You will also find the basic picture quality adjustments within this menu.

Open the Main menu



Move to your choice

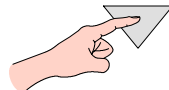

Access your choice

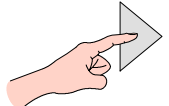

Increase or decrease levels or move to the Sound or Setup menus.

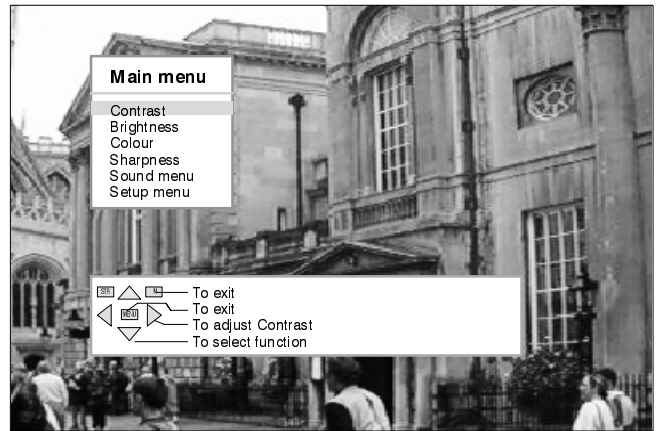
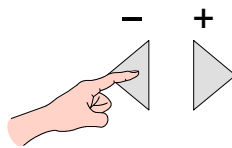

**Contrast**

The Contrast level of the TV can be adjusted, to suit the lighting conditions of the room, as necessary.



**Brightness**

The Brightness level can be adjusted to suit your viewing conditions.



**Colour**

The Colour level can be adjusted to your own preference.



**Sharpness**

The picture can be softened or sharpened to your own preference.



**Tint**

The Tint adjustment will only appear as a menu item if you have an NTSC signal source connected to the TV and will allow adjustment of the hue.

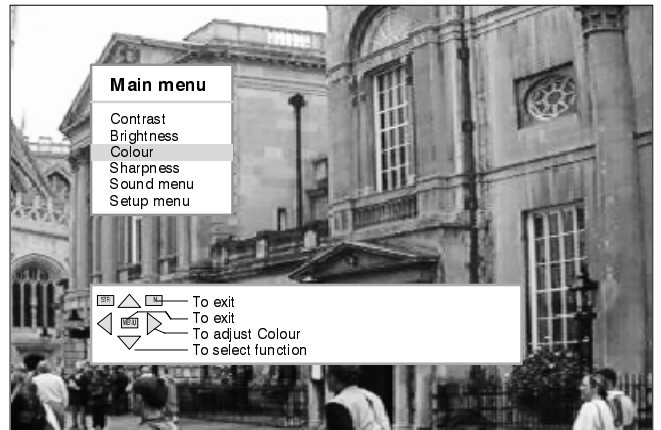

**Sound Menu**

Leads to the Sound menu and allows adjustments to be made to the sound quality.



**Setup Menu**

Leads to the Setup menu for various feature adjustments.

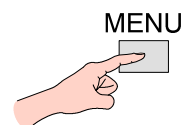

To close Main menu

# SOUND MENU

The Sound menu will allow you to set your personal preferences for all aspects of sound quality

Open the Main menu

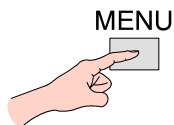

Move to Sound menu

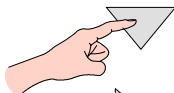

Access Sound menu

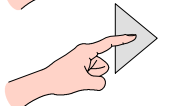

Move to your choice

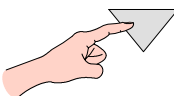

Increase or decrease levels, choose from options or access the Surround menu.

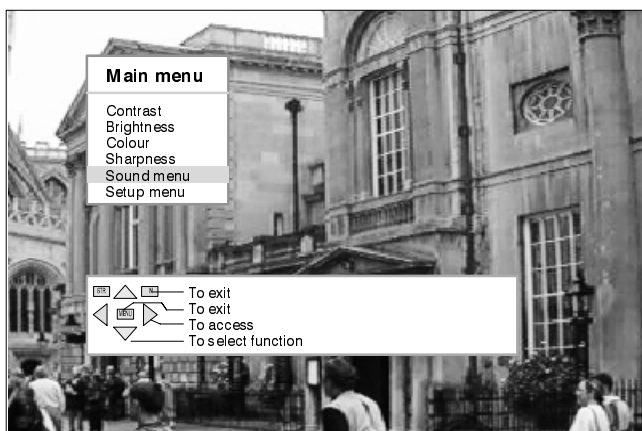
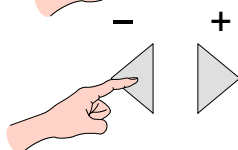

**Bass**

Bass adjustment will emphasise the lower, deeper frequencies and can be increased or decreased.



**Treble**

Treble adjustment will emphasise the sharper, higher frequencies and can be increased or decreased.



**Balance**

(Only with Surround Off – see page 26) Balance affects the levels of sound between the left and right speakers.



The headphone volume can be adjusted independently of the TV speakers so that everyone can enjoy listening at their own comfort level.

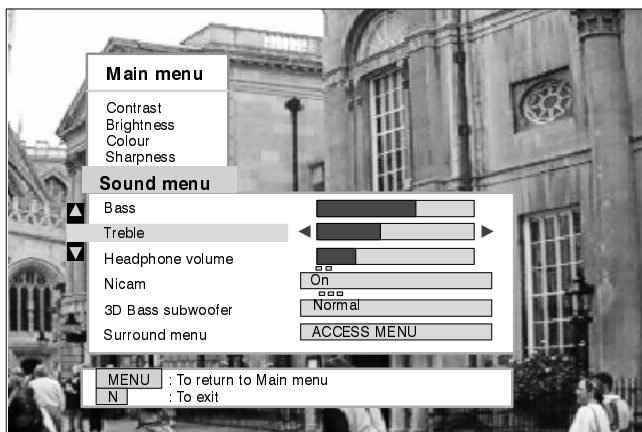

**Nicam**

Select On to provide stereo sound reproduction. Select Off for FM Mono sound output. If Nicam Mono is being transmitted select either FM Mono (Off), Nicam Mono I (M1) or Nicam Mono II (M2). The options depend upon the signal being transmitted. If reception deteriorates it is advisable to switch to FM Mono (Off). When Nicam transmissions are not being received the sound will be FM Mono (Off) only.

**3D Bass subwoofer**

3D Bass subwoofer can be switched to Off, Normal, or Full for super deep bass response.

**Surround Menu**

Leads to the Surround menu for Dolby Pro Logic and simulated modes of operation, as described on pages 25 to 27.

**Volume Correction**

Volume Correction (in AV mode only) allows different volume levels to be set for TV and AV signals. See page 24.

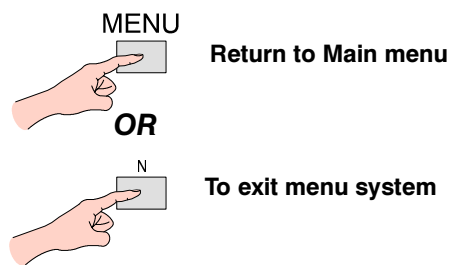

# SETUP MENU

The Setup menu provides access to various advanced features and also to the Tuning menu

Open the Main menu

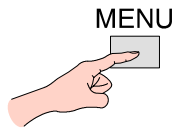

Move to Setup menu

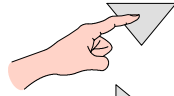

Access Setup menu

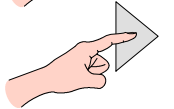

Move to your choice

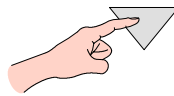

Increase or decrease levels or choose from options

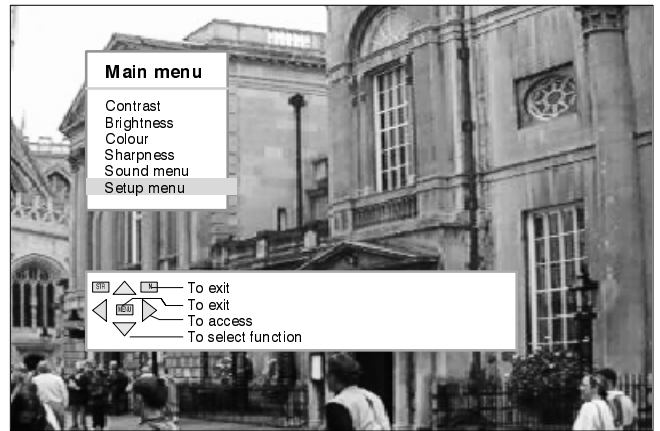
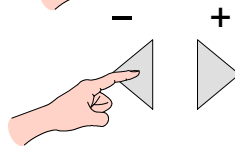

AI automatically analyses the incoming picture and processes it to give improved contrast, optimum field of depth and vivid colour tones.



P-NR will automatically reduce unwanted picture interference.

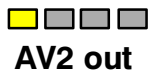

AV2 offers you a choice of signals to send to the AV2 SCART socket. You can choose from the current TV programme position, the signal entering AV1/AV3 or monitor – the picture displayed on screen.



Off timer will switch the TV off after a preset time has elapsed. You can choose from between 0 to 90 minutes in 15 minute intervals.



You will normally find that **Flicker reduction** is best set to ON to reduce any slight picture movement. However, it is possible that some occasional broadcasts may benefit by selecting the OFF position.

**Tuning menu**

Leads to Tuning options, as described on Pages 15 to 23.

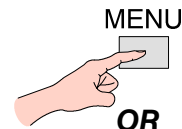
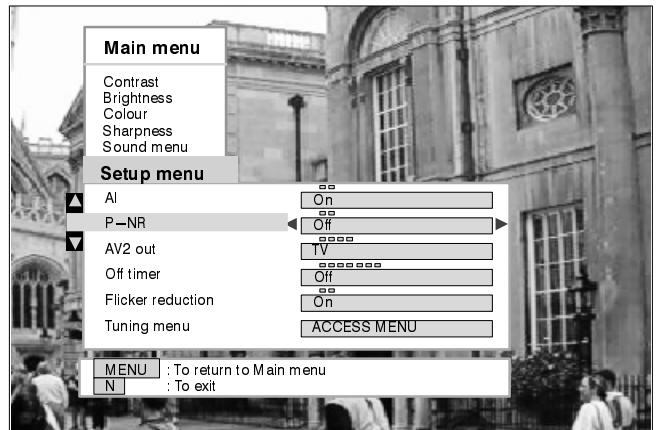

Return to Main menu

OR

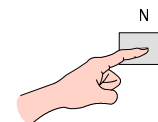

To exit menu system

# TUNING MENU

The Tuning menu provides access to both manual and automatic tuning menus

Open the Main menu

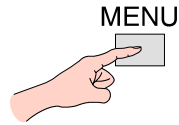

Move to Setup menu

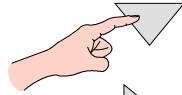

Access Setup menu

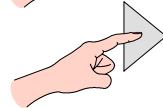

Move to Tuning menu

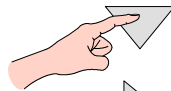

Access Tuning menu

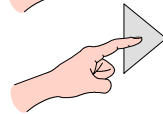

Move to your choice

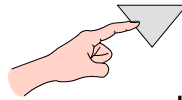

Increase or decrease levels, choose from options or access menus.

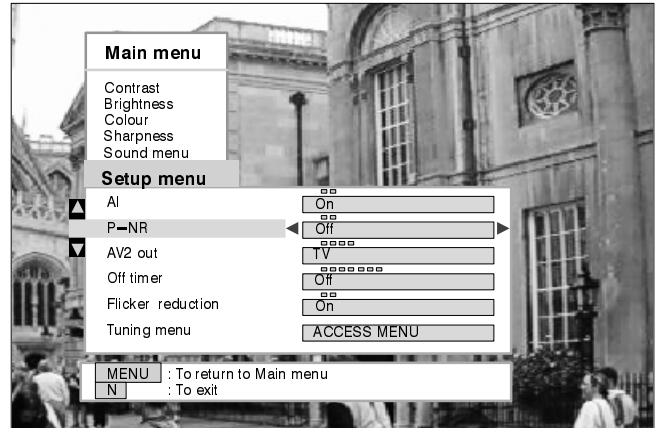
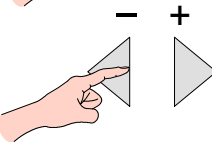

## Programme edit

Accessing Programme edit menu will allow stations to be moved, added, deleted, named and locked. Further details on page 16.

## Auto setup

The Auto setup menu allows you to automatically retune the TV. Further details on page 21.

## Manual tuning

The Manual tuning menu allows individual programme positions to be tuned manually. Further details on page 22.

## Shipping condition

Allows you to clear all tuning information and reset all control levels back to factory settings. Further details on page 23.

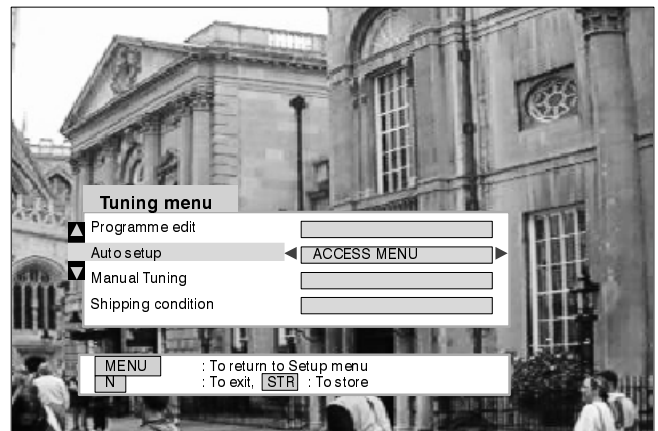

MENU

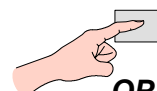

Return to Setup menu

OR

N

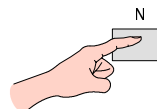

To exit menu system



# TUNING MENU – Programme edit

The Programme edit menu allows you to delete, add, move, retune, name and lock channels

Open the Main menu

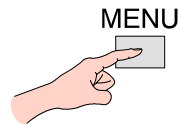

Move to Setup menu

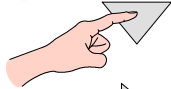

Access Setup menu

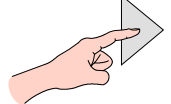

Move to Tuning menu

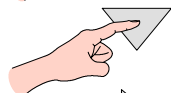

Access Tuning menu

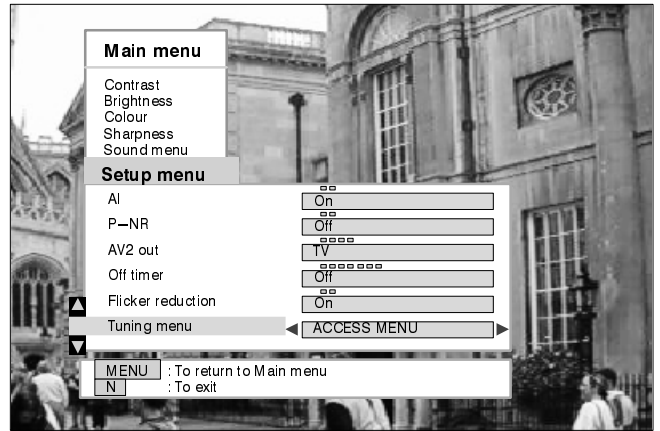
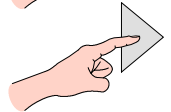

Move to Programme edit

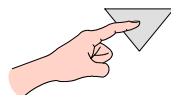

Access Programme edit

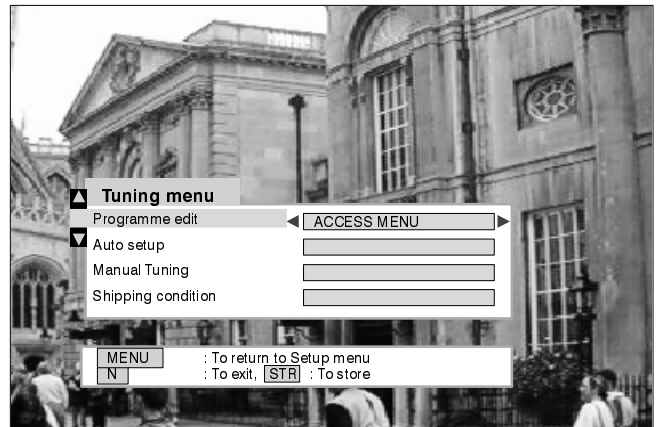
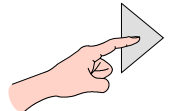

## To delete an unwanted programme position

Choose the programme position

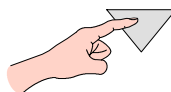

Press the red key on remote control

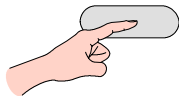

Press STR to delete

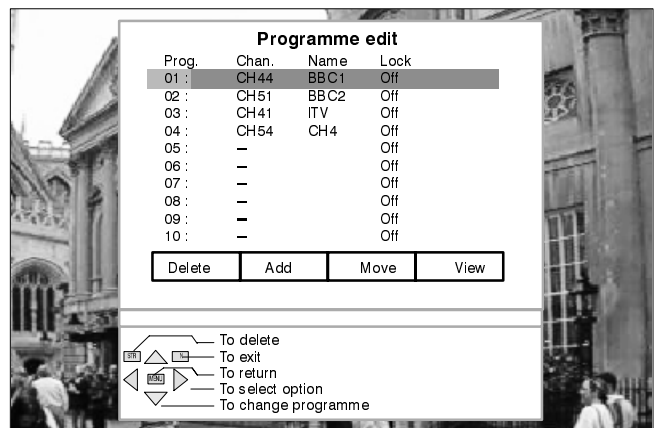
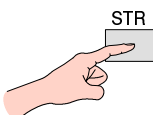

**Note :**  
 It is not possible to delete the VCR channel.

If you have completed changes to the Programme edit menu then

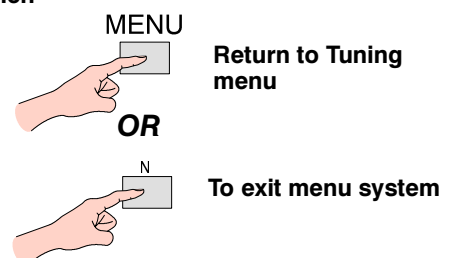

# TUNING MENU – Programme edit

## To add a programme position

Choose where to add a blank programme

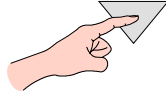

Press the green key

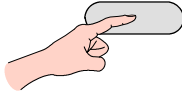

Press STR to add

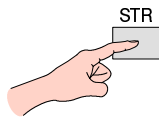

This blank programme can then be tuned, named, locked, moved or viewed.

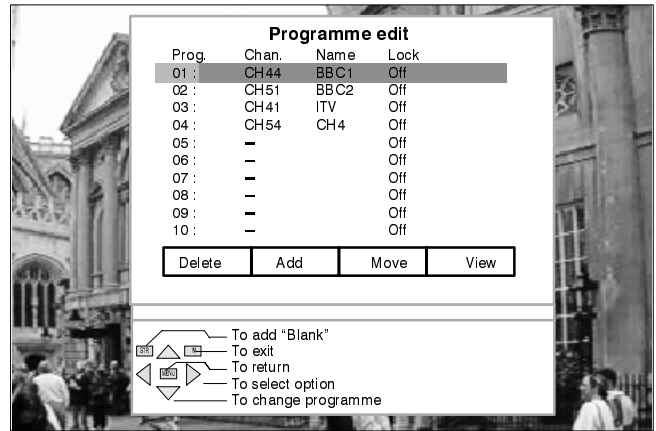

If you have completed changes to the Programme edit menu then

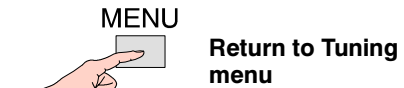

OR

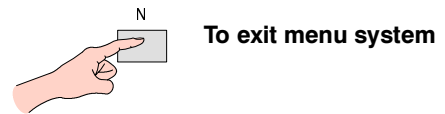

## To move a programme to another position

Choose the programme position

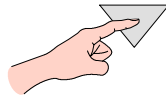

Press the yellow key on remote control

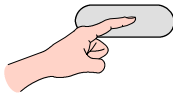

Choose new position

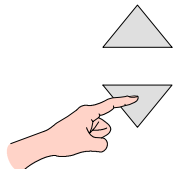

Press STR to store

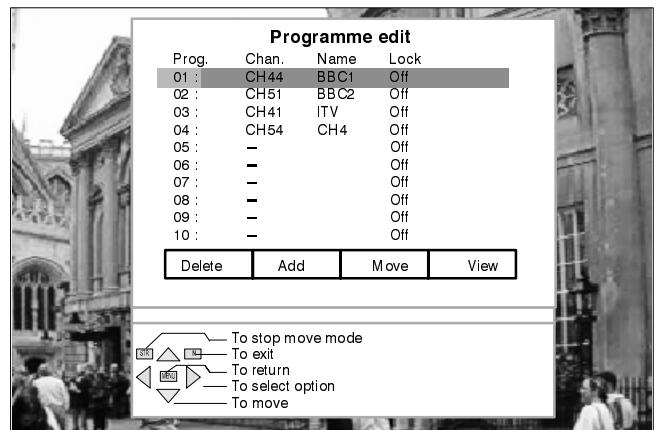
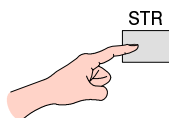

If you have completed changes to the Programme edit menu then

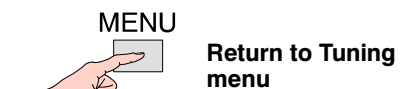

OR

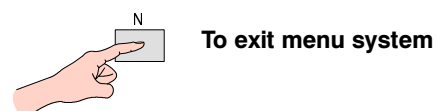

# TUNING MENU – Programme edit

## To view a programme position

Choose the programme position

Press the blue key on remote control

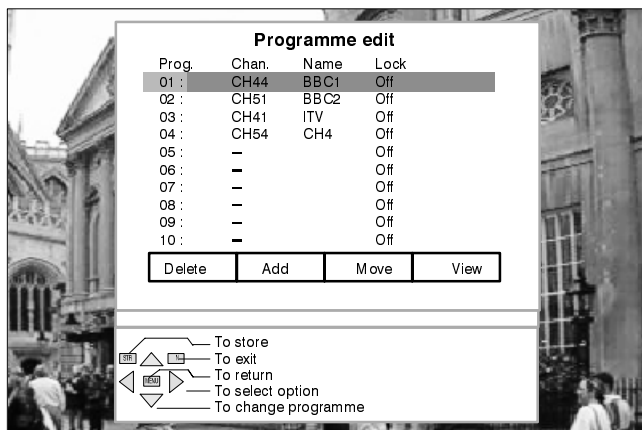
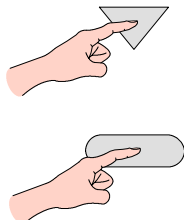

The screen will return to Programme edit after a few seconds

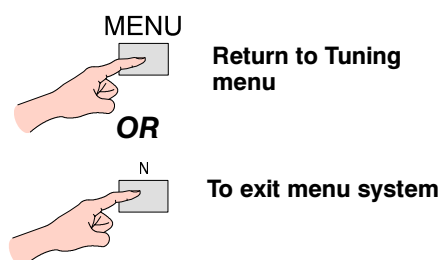
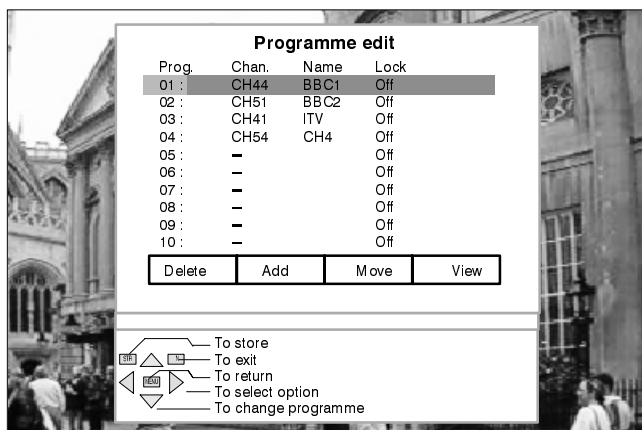
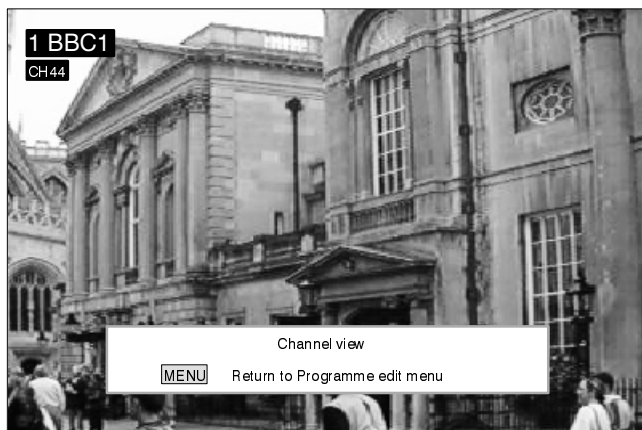

# TUNING MENU – Programme edit

## To tune a programme position

Choose the programme position

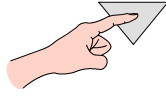

Move to the channel setting

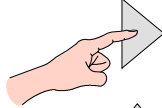

Increase or decrease channel number

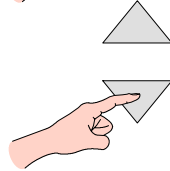

Press STR to store

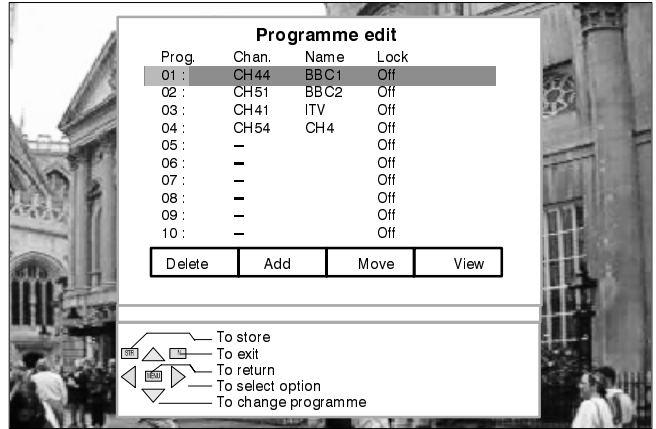
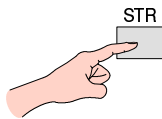

If you have completed changes to the Programme edit menu then

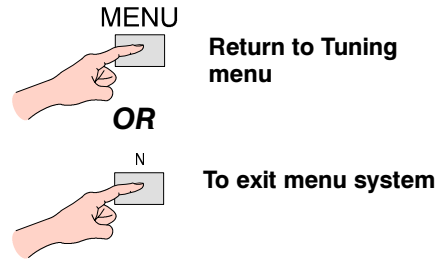

## To rename a programme position

Choose the programme position

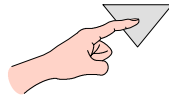

Move to the Name position

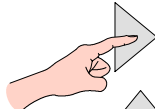

Choose the new character



Move to the next character position

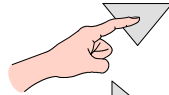

Continue until renaming is completed

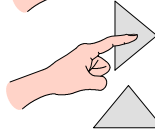

Press STR to store

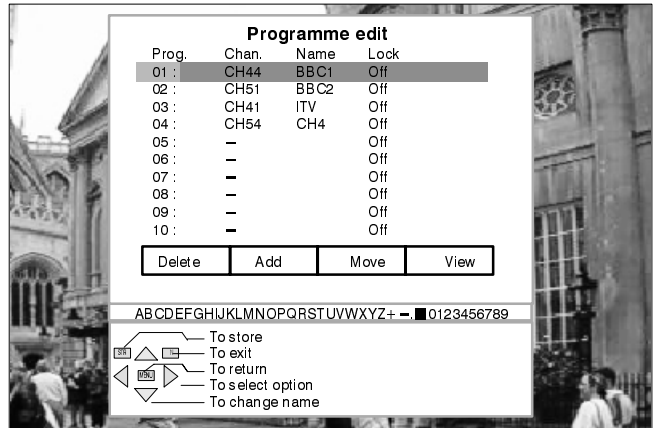
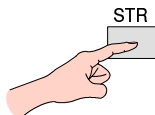

If you have completed changes to the Programme edit menu then

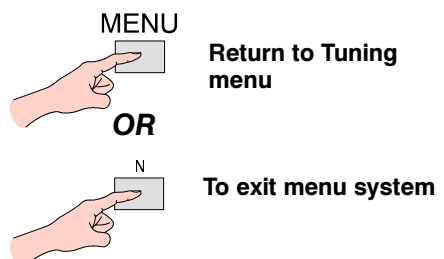

# TUNING MENU – Programme edit

To lock a programme position to prevent access

Choose the programme position

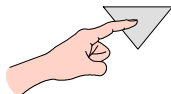

Move to the lock position

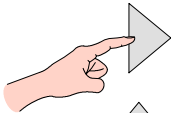

Choose between lock on or lock off

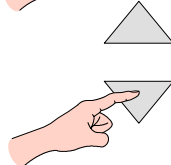

Press STR to store

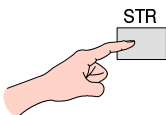

Access to the locked programme position is prevented.

When a programme position is locked, Direct Channel Access using the 'C' and numeric keys on the remote control is not available.

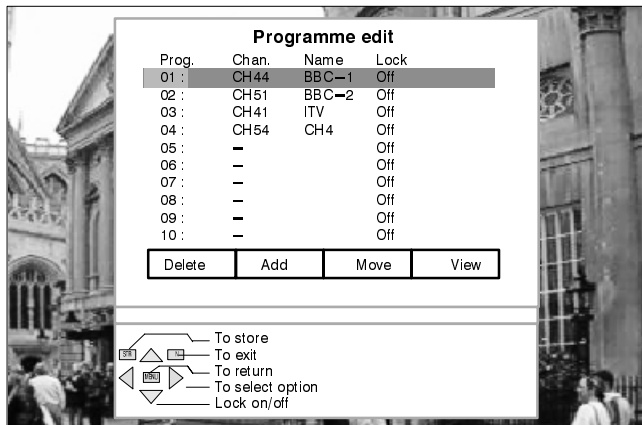

If you have completed changes to the Programme edit menu then

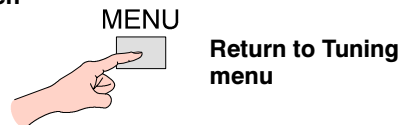

OR

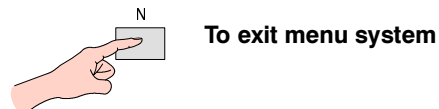

# TUNING MENU – Auto setup

The Auto setup menu will allow you to automatically retune the TV to your local stations. It is useful if you move to a different region.

Open the Main menu

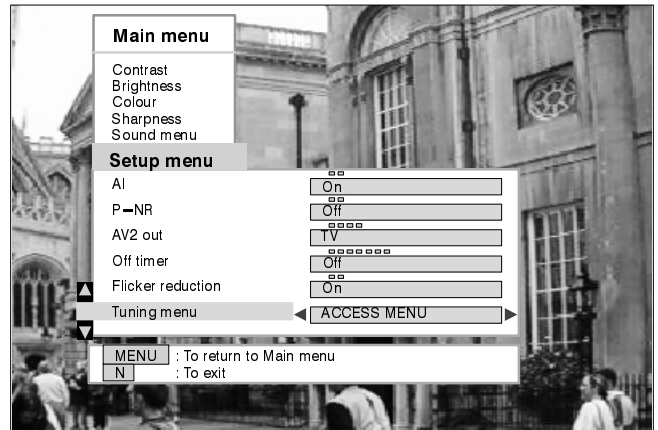
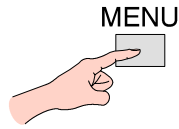

Move to Setup menu

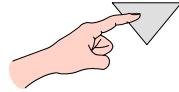

Access Setup menu

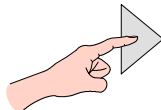

Move to Tuning menu

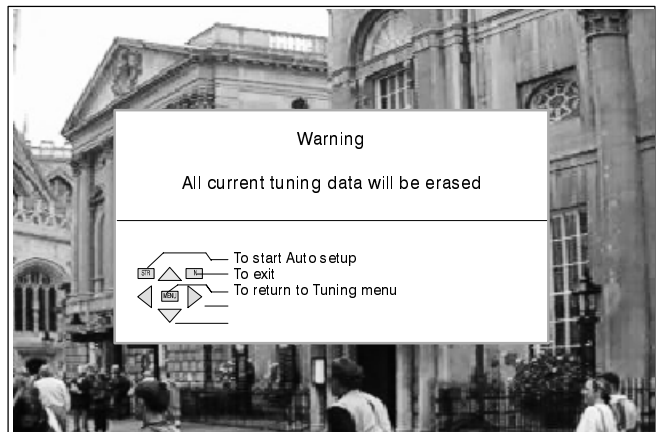
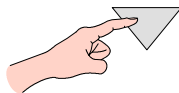

Access Tuning menu

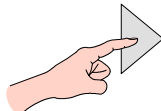

Move to Auto setup

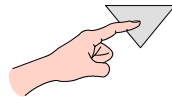

Access Auto setup menu

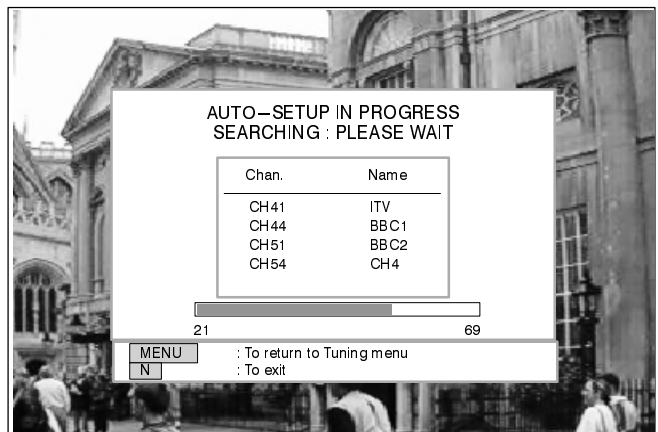
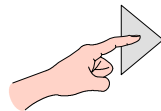

Press to start Auto setup

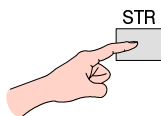

The TV will search for, locate and order your local stations.

Once this operation is completed the TV will display programme position 1.

Note :

The sorting order depends upon the TV signal, the broadcasting system, and reception conditions. If the order is not to your preference it can be rearranged. Refer to the Programme Edit menu – see page 16 for details.

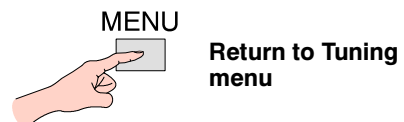

OR



# TUNING MENU – Manual tuning

Manual tuning of the Programme positions is available either from the on screen display menu or from the front panel controls

## Manual tuning menu

Open the Main menu

MENU



Move to Setup menu



Access Setup menu



Move to Tuning menu



Access Tuning menu



Move to Manual tuning



Access Manual tuning



Select the programme position



Start tuning



Press STR to store

STR

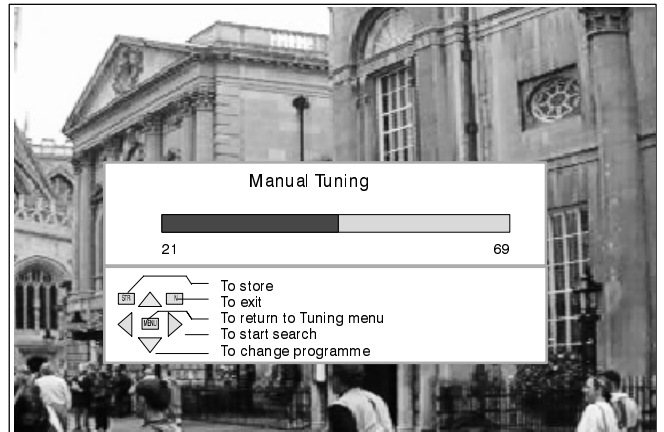
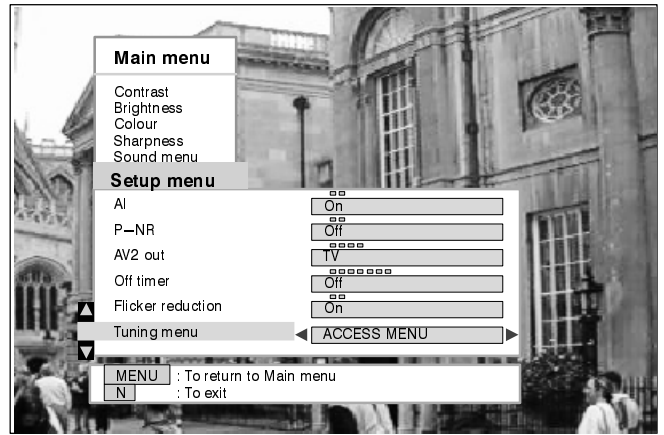

## Manual tuning (Front panel)

Press the F button (Front panel) until "Tuning mode" is reached

F



Press the - or + button to access "Tuning mode"

-/V



Press the TV/AV button to change to the required programme position

TV/AV



Press the - or + button to start the tuning search

-/V



Press STR to store changes

STR



Press the F button to exit

F

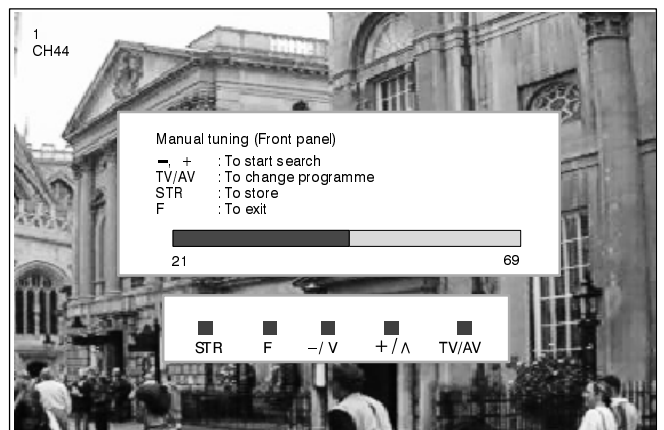
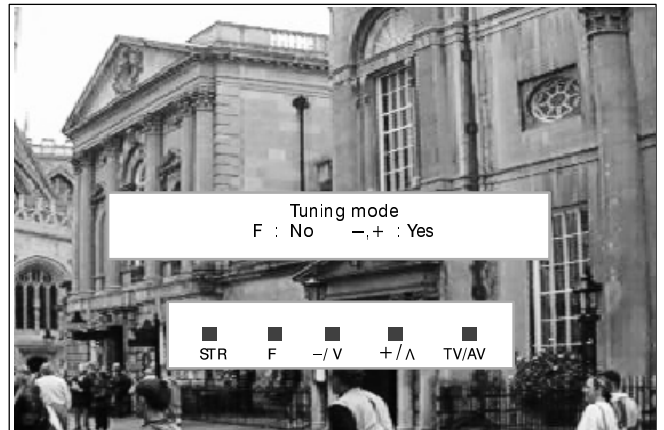

# TUNING MENU – Shipping condition

**Shipping condition allows you to reset the TV to its original condition, i.e. no channels tuned in.**

This is useful for example, if you move to a different area then you will probably want the TV to tune itself to your new local stations.

This can be done either through the **Shipping Condition** menu or through the **Auto setup** menu.

The **Shipping condition** menu will reset all data, clearing all tuning information and resetting all control levels back to factory settings. You may need to adjust your VCR or programme position '0' VCR after operating the **Shipping Condition** menu – refer to page 30.

**Open the Main menu**

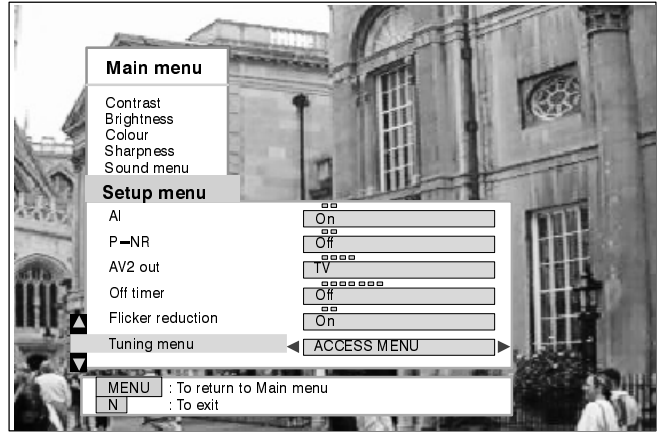
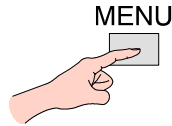

**Move to Setup menu**

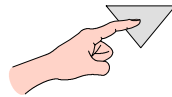

**Access Setup menu**

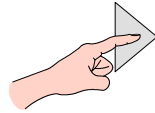

**Move to Tuning menu**

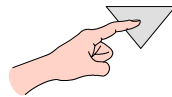

**Access Tuning menu**

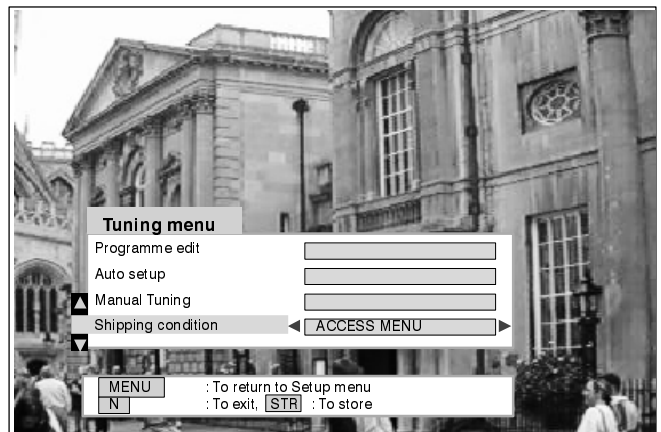
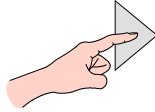

**Move to Shipping condition**

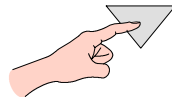

**Access Shipping condition**

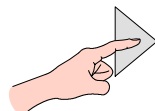

**Press STR to start**

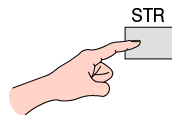

**Press again, to confirm, when you are asked, "Are you sure?"**

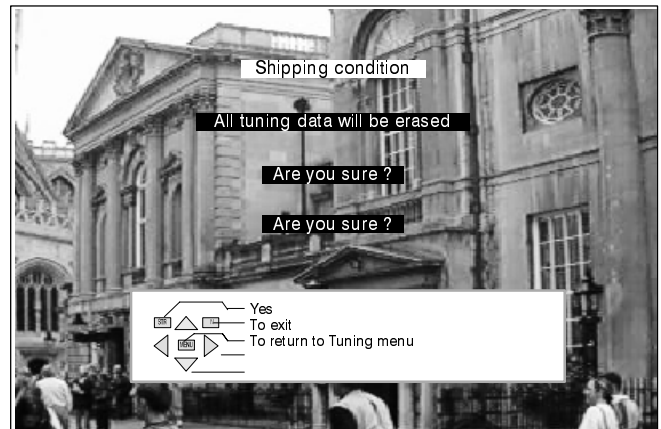
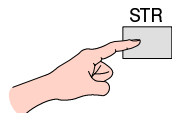

**Switch TV off and wait for a few seconds.**

**Switch TV on again.**

**Auto setup tuning will begin, stations will be located, sorted and stored ready for use. See Page 21 for details.**

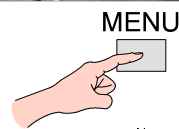
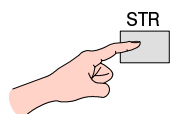

**Return to Tuning menu  
OR**

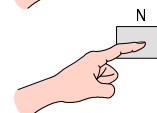

**To exit menu system**



# AV SELECT and SETUP

The AV Select menu will allow you to choose which AV source to view.

Press the TV/AV key  
(remote control or TV)

Press the appropriate coloured  
key of remote control (whilst the  
options remain on screen)

Press the green or yellow keys  
again to select S-Video input

You may wish to make  
adjustments in the Setup or Sound  
menus

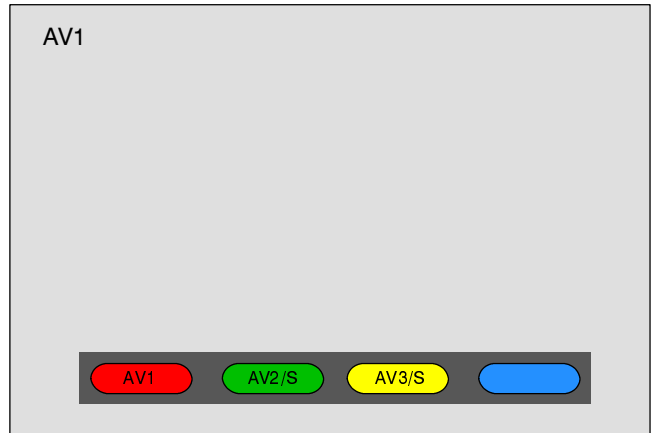
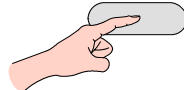
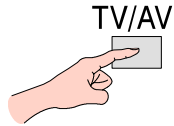

## Setup Menu

Open the Main menu

Move to Setup menu

Access Setup menu

Move to your choice

Choose from options

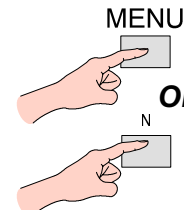
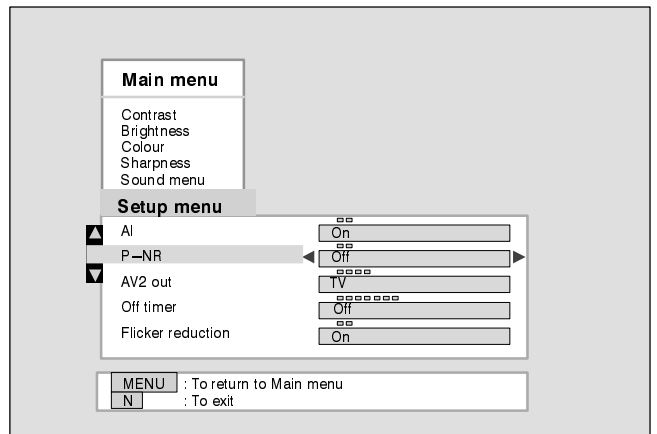
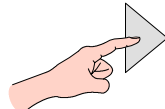
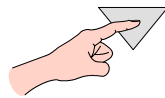
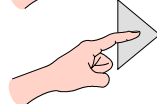
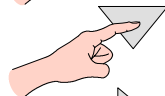
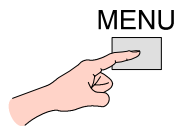

Return to Main menu

OR

To exit menu system

## Sound Menu

Open the Main menu

Move to Sound menu

Access Sound menu

Move to your choice

Increase or decrease levels,  
choose from options or access the  
Surround menu.

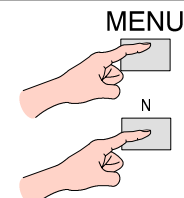
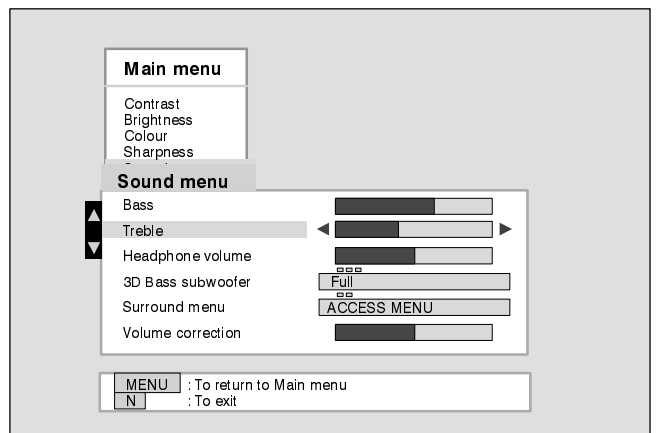
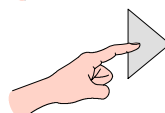
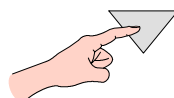
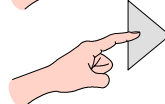
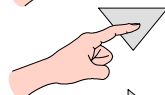
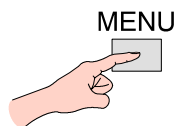

Return to Main menu

OR

To exit menu system

# SURROUND MENU

Normally stereo reproduction uses left and right speakers, but **Dolby Pro Logic Surround** also uses a centre channel and a rear channel. The centre channel sharpens sound perspective and dialogue clarity whilst the rear channel is used to immerse the viewer in ambience and special effects. The reproduction is further enhanced by the **Dolby Pro Logic** decoder incorporated to generate clearer positioning of sounds and a full effect over a wider listening area.

To use Dolby Pro Logic Surround when receiving television programmes that have been produced with the Dolby Pro Logic Surround information, you must be able to receive NICAM Stereo transmissions, if NICAM Stereo transmissions are not transmitted in your area then the Dolby Pro Logic Surround information will not be present and it will not be possible to use Pro Logic operation (unless you are playing back from a stereo VCR).

**Dolby Pro Logic Surround** will operate with videos, laser discs and TV programmes that bear the **Dolby Surround** logo :



Open the Main menu



Move to Sound menu



Access Sound menu



1. Move to Bass setting  
Adjust to centre position



2. Move to Treble setting  
Adjust to centre position

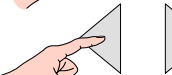

3. Move to 3D Bass subwoofer  
Adjust to Normal position



Move to Surround menu



Access Surround menu



Move to your choice

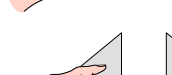

Choose from options or access the speaker level menu.



**Surround mode**



**Pro Logic / Simulated setting**

Choosing Pro Logic allows selection of Normal, Phantom or 3 Stereo modes, as described on Page 26.

Choosing Simulated allows selection of Disco, Movie or Stadium modes, as described on Page 27.

**Speaker level**

Allows adjustment of the output levels for each channel, as described on Page 27.

**Speaker distance Front / Rear**



Allows setting of the distance from the listening position to the front and rear speakers. If the rear surround speakers are closer to you than the centre speaker, you may hear dialogue "leakage" from the rear surround speakers. It may be necessary to reduce the output level of the rear channel to rectify this phenomenon.

**Internal Speaker**



Normally set to **On**, but, when separate external amplified front speakers are connected, then the internal speakers can be switched **Off**. See Page 34 for connection details.

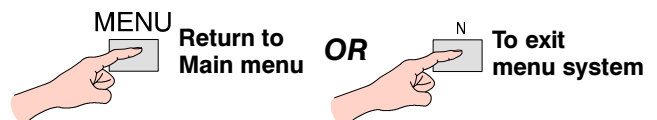
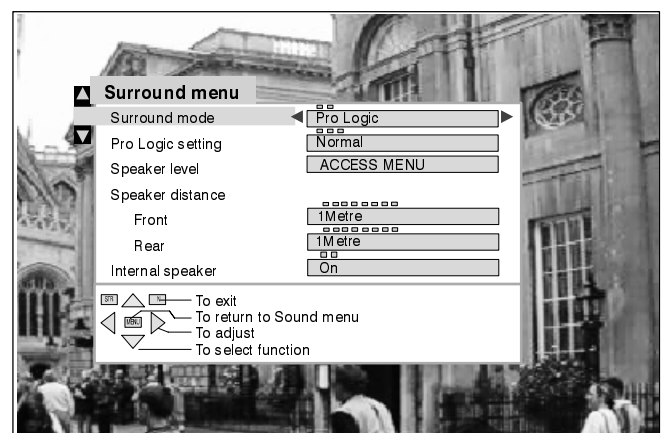
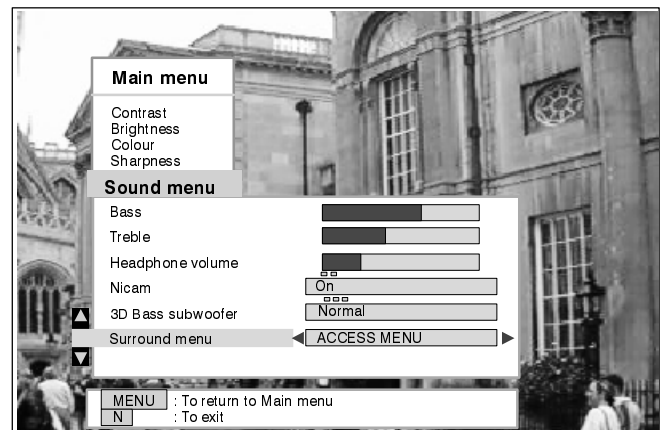

# PRO LOGIC MODE

Choosing Surround Pro Logic mode allows three possible modes of operation :

**Normal, Phantom or 3 Stereo.**

## Dolby Surround Pro Logic **Normal** mode

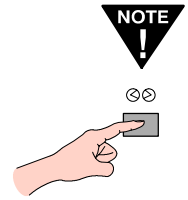
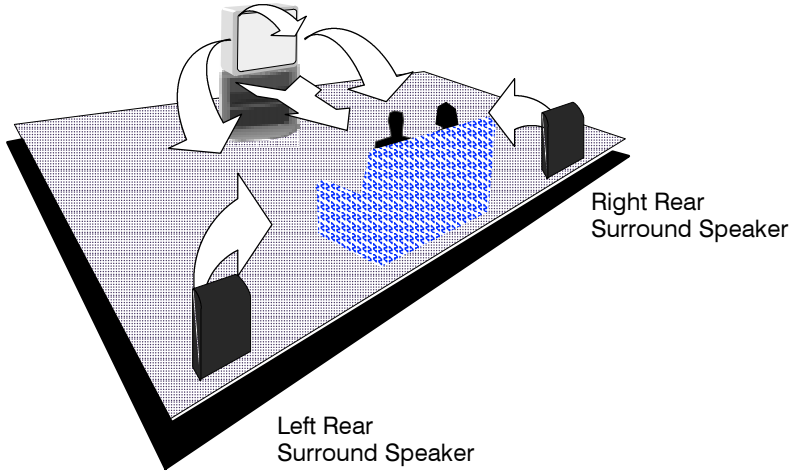

Pressing the Surround switch will switch the surround mode into 2 channel stereo only (and vice-versa)

When the Surround function is switched to the Off position, it will allow a Balance control as an extra option in the sound menu.

## Dolby Surround Pro Logic **Phantom** mode

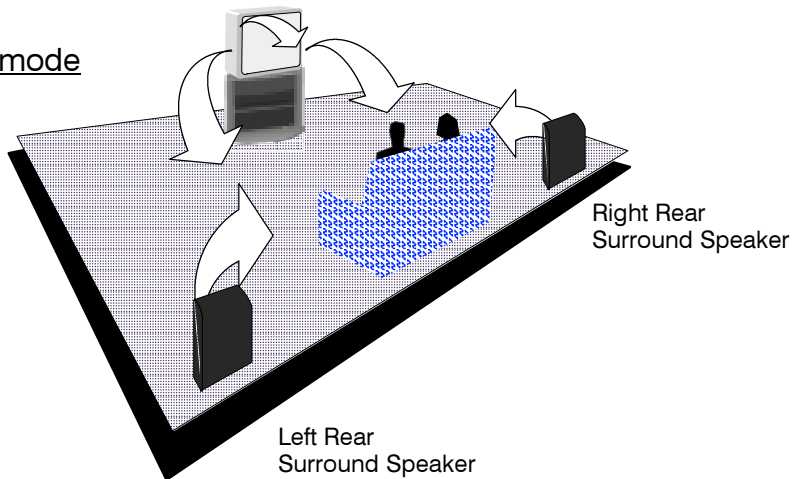

## Dolby Surround Pro Logic **3 Stereo** mode

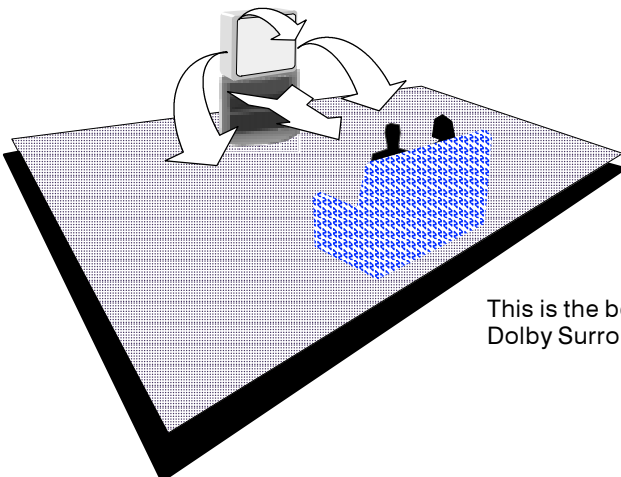

This is the best mode to use if rear speakers are not connected. It offers Dolby Surround Pro Logic effect but without the rear surround speakers.

## SIMULATED MODE

Simulated surround modes allow various types of surround effects to be produced by mimicking both the direct sound, as heard by the audience, and the sound reflected back from the surrounding walls e.g. ceiling and floor space in a space such as a Disco. There are three different effects to choose from, each reflecting a different atmosphere.

Setting	Effect	Appropriate sources
Disco	A room so full of music that it seems to engulf the listener.	Disco, Dance or Jazz music.
Movie	Playback of software (films) not encoded with Dolby surround.	All movies or music software recorded without Dolby surround.
Stadium	A large sports stadium packed for a live game.	Any live sports occasion.

## SPEAKER LEVEL SETUP

The speaker output levels from the different options, e.g. Left, Centre, Right and Rear should be adjusted, from your usual listening position, to obtain the best results. The level can be set using either the TV sound or the provided test signal. When using external stereo equipment, it is advisable to set the speaker levels to the midpoint position.

The adjustments available will vary according to the mode chosen.

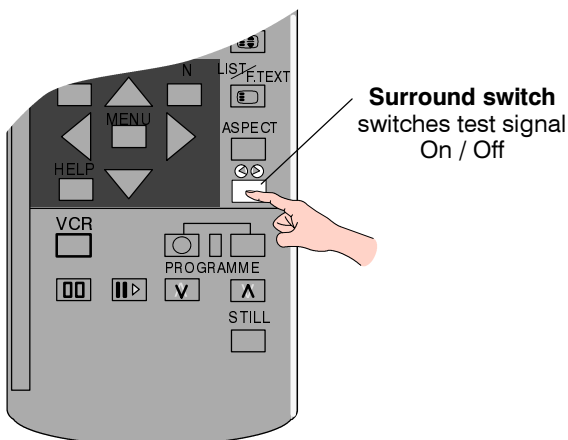

Speaker level setup shown in Pro Logic mode

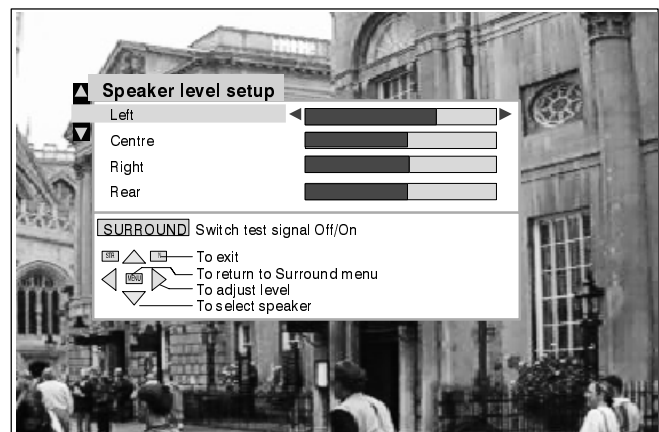

# TELETEXT OPERATION

---

- Teletext features may vary depending on the Broadcasting Companies and is only available if the channel selected is transmitting Teletext.
- Pressing the **MENU** key whilst in Teletext operation will display the contrast function with a cyan bar, press ◀ ▶ to alter the setting as required.
- When in teletext mode, the volume may still be altered to the desired listening level.

## What is LIST mode?

In LIST mode, four differently coloured page numbers are situated at the bottom of the screen. Each of these numbers can be altered and stored in the TV's memory.

## What is FASTEXT?

In FASTEXT mode, four differently coloured subjects are situated at the bottom of the display. To access more information about one of these subjects, press the appropriately coloured button. This facility enables fast access to information of the subjects shown.

---

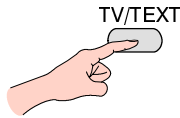

### TV / Teletext mode

Press the **TV/TEXT** key.  
The screen will display the Teletext page.  
Press again when you wish to return to TV. mode.

---

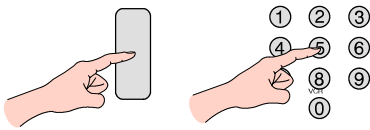

### Page Selection

Pages can be selected in two ways :

- Press the Up / Down keys to increase or decrease the page number by one.
- By entering the page number, using 0 –9 on the remote control.

---

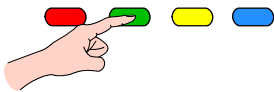

### Red / Green / Yellow / Blue keys

In FASTEXT mode these correspond to the differently coloured subjects.  
In LIST mode they correspond to the differently coloured page numbers.

---



### List / F.text

#### When in List / Fastext operation

Press to change from FASTEXT mode to LIST mode and vice versa.  
In FASTEXT mode four differently coloured subjects are displayed at the bottom of the page. Press the appropriate coloured key to access more information about one of these subjects.

---

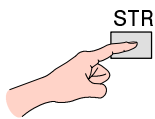

### List Store

In LIST mode the four page numbers can be altered for channel positions 1 – 25 only.  
To do this, press one of the coloured keys and enter the new page number.  
Press and hold **STR**, the page numbers will change colour.

---

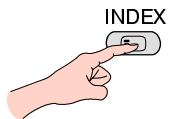

### Index

#### When in FASTEXT operation

Press **INDEX** to return to the main index page.  
Depending on the way information is transmitted, this may have to be pressed more than once to return to the main index page.

---

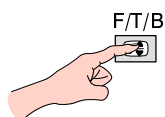

### Full / Top / Bottom

Press to expand the **TOP** half of the page.  
Press again to expand the **BOTTOM** half.  
Press again to return to normal (**FULL**) size.

---



### Reveal

Press to reveal hidden words e.g. quiz page answers.  
Press again to hide.

---

# TELETEXT OPERATION

---

It is not possible to change the programme position when in News flash, Update or Sub Coded Page Access operation.

---

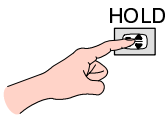

## Hold

To hold the Teletext page when viewing multipage information.  
Press again to return to automatic page update.

---

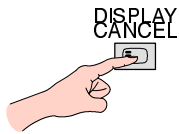

## Display Cancel

Press **DISPLAY CANCEL** to view the TV picture whilst searching for a Teletext page.  
When found, the screen will display the page number at the top left.  
Press **DISPLAY CANCEL** to view the page.  
Press **TV / TEXT** to return to normal TV operation.

### News Flash

When a news flash page has been selected, press **DISPLAY CANCEL** to view the TV picture, when an update is received, it will be displayed on screen.  
Press **DISPLAY CANCEL** to remove updated news.  
Press **TV / TEXT** to return to normal TV operation.

### Update

Press **DISPLAY CANCEL** to see the update of information on certain pages.  
When an update is received, the page number will be displayed at the top left of the screen.  
Press **DISPLAY CANCEL** to view the page.  
Press **TV / TEXT** to return to normal TV operation.

---

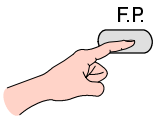

## Favourite Page (F.P.)

Stores a favourite page in memory for instant recall. To store such a page, the TV must be in LIST mode, and the programme position must be from 1 – 25. Press the **BLUE** key, select the page number, then press **STR**. The page number is now stored.  
Press **F.P.** to recall this page.

Depending on the transmission sequence, when the F.P. key is pressed, the contents of the favourite page may take some time to appear. Only the page number is stored, not it's contents.

---

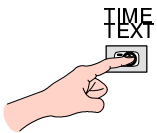

## Sub Coded Page Access

When teletext information exceeds more than one page, it may take some time for the automatic changing of the sub pages to reach the sub page you require. It is possible to enter your required sub page and continue watching the normal programme until the correct sub page is found.

Select the required page number using keys 0 – 9.

Press **TIME TEXT**, \*\*\*\* will be displayed (top right of the screen).

Enter desired sub page number before the \*\*\*\* disappears.  
To select page 6 enter 0, 0, 0 and 6.

If in LIST mode, a 'T' will appear in the current box at the bottom.

Press **DISPLAY CANCEL** to view a normal TV programme.

When the page is available, press **DISPLAY CANCEL** to view the page.

To clear the page perform one of the following :

- Select a new page number.
- Press **TV/TEXT** to return to normal TV operation.

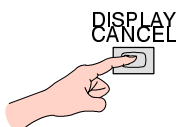
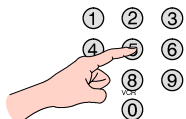

# VCR AND SATELLITE RECEIVER INSTALLATION

Your new TV is supplied with programme position '0' set to receive an RF signal from your VCR.

However, if for some reason your VCR is tuned to a different RF channel then you will not receive any picture or sound from your VCR on programme position '0' of the TV. It will be necessary to either adjust the RF channel of your VCR or to adjust the tuning of the TV's programme position '0' or both until it receives the RF output channel of your VCR.

**It is intended that this advice is used in conjunction with the instruction books for your ancillary equipment.**

To connect a VHS VCR use the AV1 socket. To connect an S-Video VCR use the AV2 socket.

## TO TUNE YOUR VCR TO THE TV

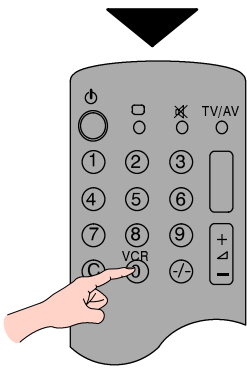
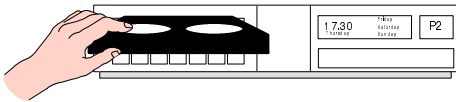

### RF CHANNEL ADJUST

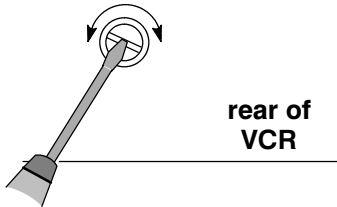

**Note :**  
Some VCR's are capable of adjusting their RF channel via their remote control unit.



**Insert recorded tape and select playback**

**Set TV to programme position '0' VCR**

**Adjust tuning**

**Operation completed**

**See below for installation of VCR and Satellite Receiver**

## TO TUNE YOUR TV TO THE VCR

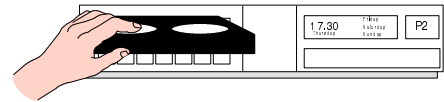

**Access the Manual tuning menu as detailed on page 22.**

▼ ▲ To select programme position '0'  
◀ ▶ To start search for VCR playback  
Programme position and current channel are displayed top left of screen

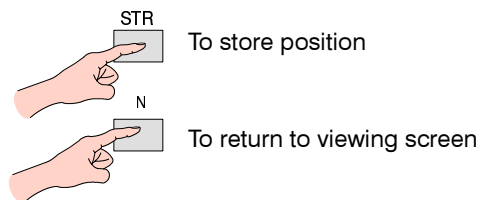
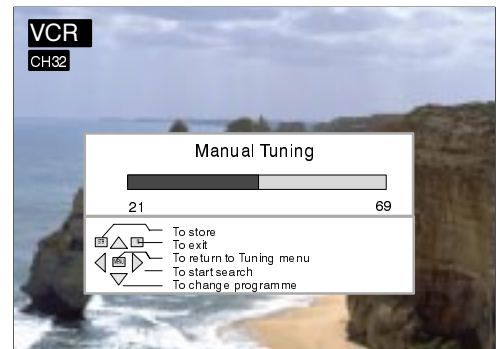







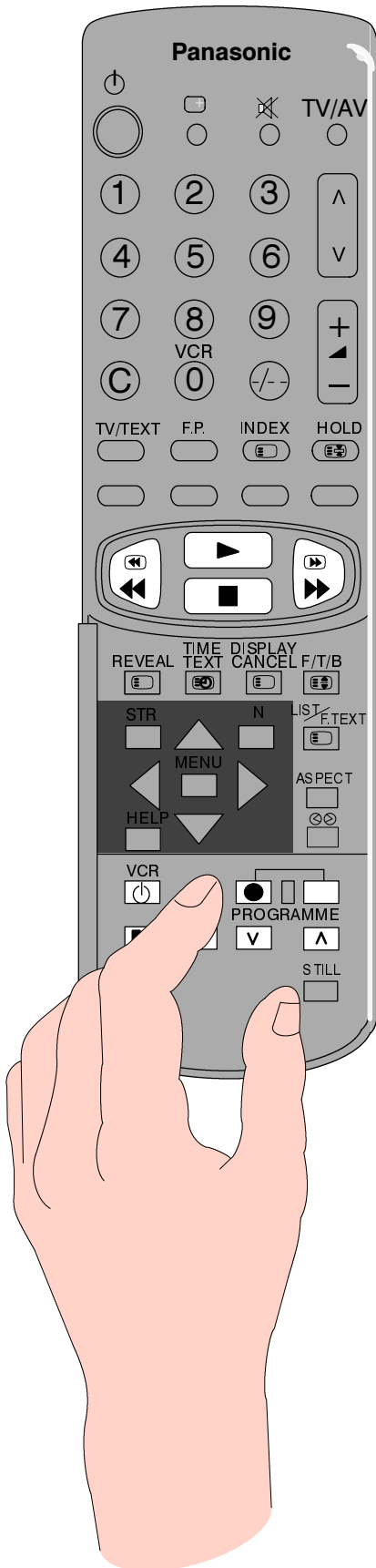

If you are going to use a Satellite Receiver and a VCR **it is important**, to avoid tuning problems, that they are both tuned to output their signals on differing channels. For example, if your VCR is tuned to output channel 32, your Satellite Receiver could be set to output channel 34. Refer to your Satellite Receiver and VCR instruction books for precise tuning information.

# VCR CONTROL

The Remote Control is capable of operating some functions of selected Panasonic VCRs, please consult your dealer for details. Some VCR have different functions, so to ensure compatibility, please refer to the VCR's instruction book.

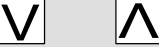

<p>VCR</p> 	<p><b>Standby</b> Press to switch the VCR to standby mode. Press again to switch back on.</p>
	<p><b>Play</b> Press to playback the tape.</p>
	<p><b>Stop</b> Press to stop the tape.</p>
	<p><b>Fast Forward / Cue</b> Press to fast forward the tape. In Play mode, press to view the picture rapidly forward.</p>
	<p><b>Rewind / Review</b> Press to rewind the tape. In Play mode, press to view the picture in reverse rapidly.</p>
	<p><b>Pause / Still</b> Press in playback mode, the picture will pause.</p>
	<p><b>Still Advance</b> While in PAUSE / STILL mode, press to advance the picture one frame at a time.</p>
	<p><b>Programme Up / Down</b> Press to increase or decrease the VCR programme position by one.</p>
	<p><b>Record</b> Press these together to record.</p>



# AUDIO / VIDEO CONNECTIONS

## Front AV3 4 Pin S-Video, RCA Audio / Video and Headphone Sockets

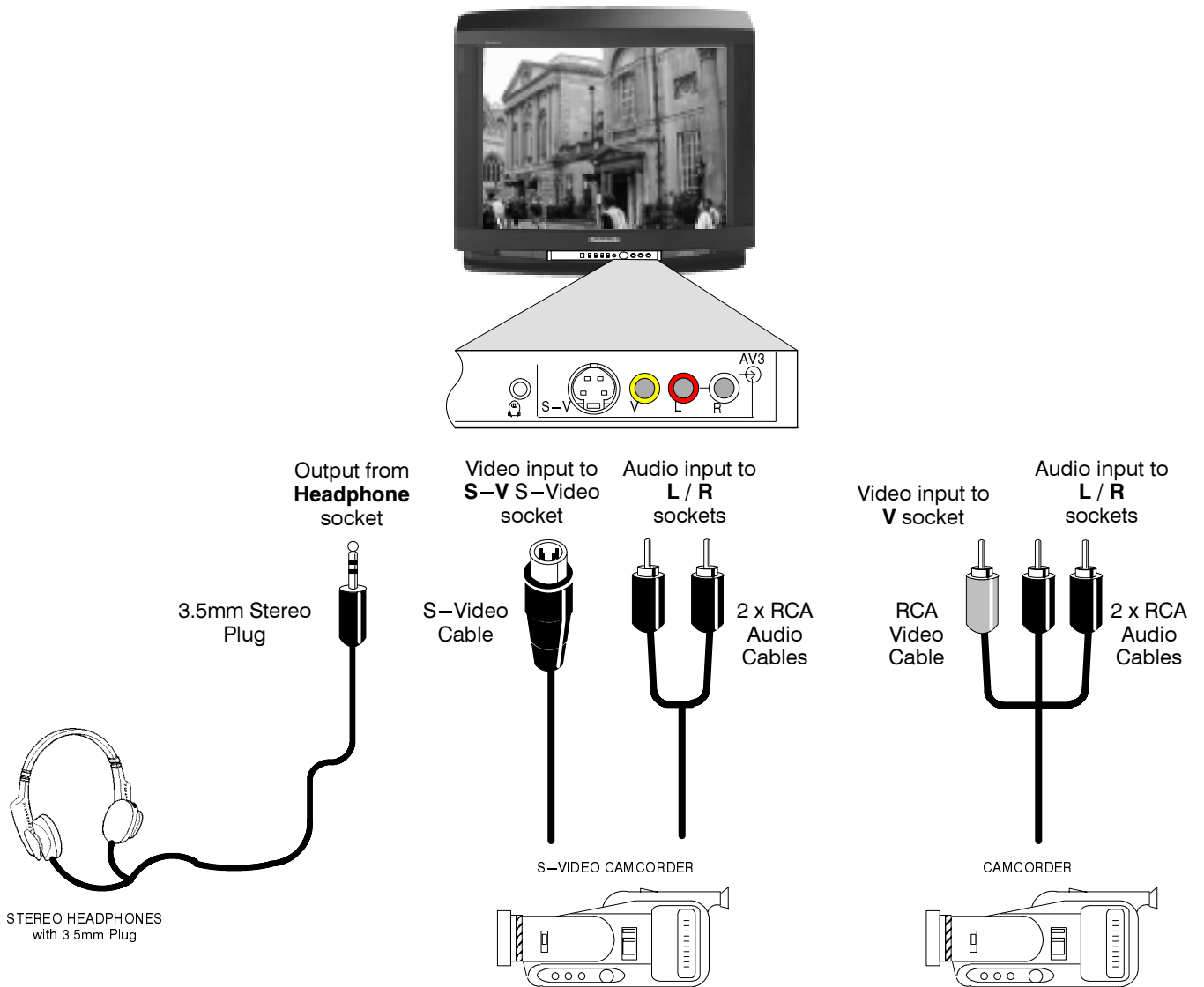

Ancillary equipment and cables shown are not supplied with this TV set.

## SCART and S-Video Terminal Information

### AV1 and AV4 21 pin SCART terminals

Socket Earth	21		20	CVBS in (video)
CVBS out (video)	19		18	RGB status earth
CVBS earth	17		16	Status RGB-AV1
Red in-AV1	15		14	Earth
Red earth-AV1	13		12	--
Green in-AV1	11		10	--
Green earth-AV1	9		8	Status CVBS
Blue in-AV1	7		6	Audio in (L)
Blue earth-AV1	5		4	Audio earth
Audio out (L)	3		2	Audio in (R)
Audio out (R)	1			

### AV2 21 pin SCART terminal

Socket Earth	21		20	CVBS in (video)
CVBS out (video)	19		18	Earth
CVBS earth	17		16	--
S.C. - In	15		14	Earth
Earth	13		12	--
--	11		10	--
Earth	9		8	Status CVBS
--	7		6	Audio in (L)
Earth	5		4	Audio earth
Audio out (L)	3		2	Audio in (R)
Audio out (R)	1			

### S-Video 4 pin terminal

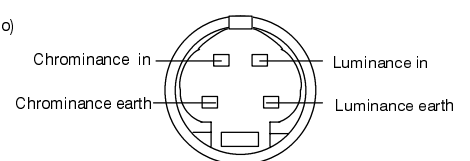

Suitable inputs for AV1 include RGB (Red/Green/Blue).

AV4 does not have RGB input capability.

AV2 - Pins 15 and 20 are dependent on AV2 S-VHS / VIDEO switching.

# AUDIO / VIDEO CONNECTIONS

## Rear AV1 / AV2(S) 21 Pin SCART and RCA Audio Out Terminals

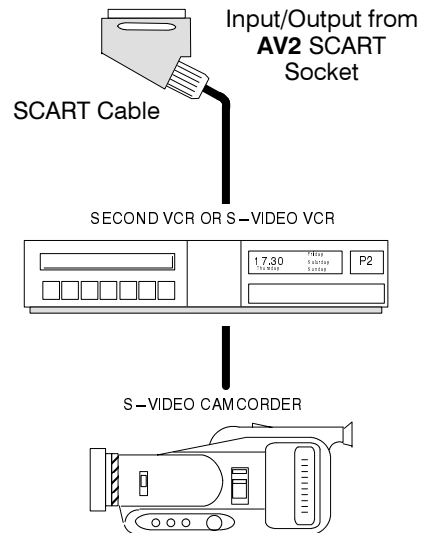
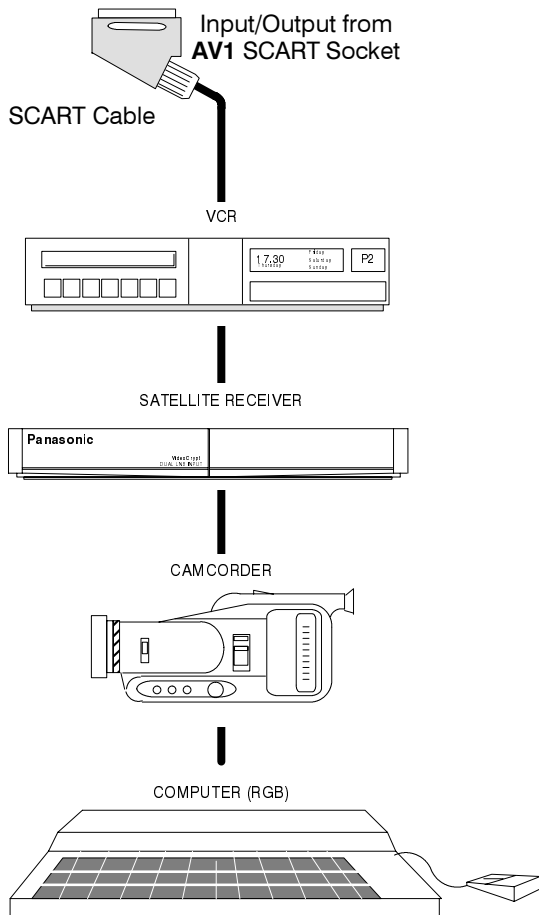
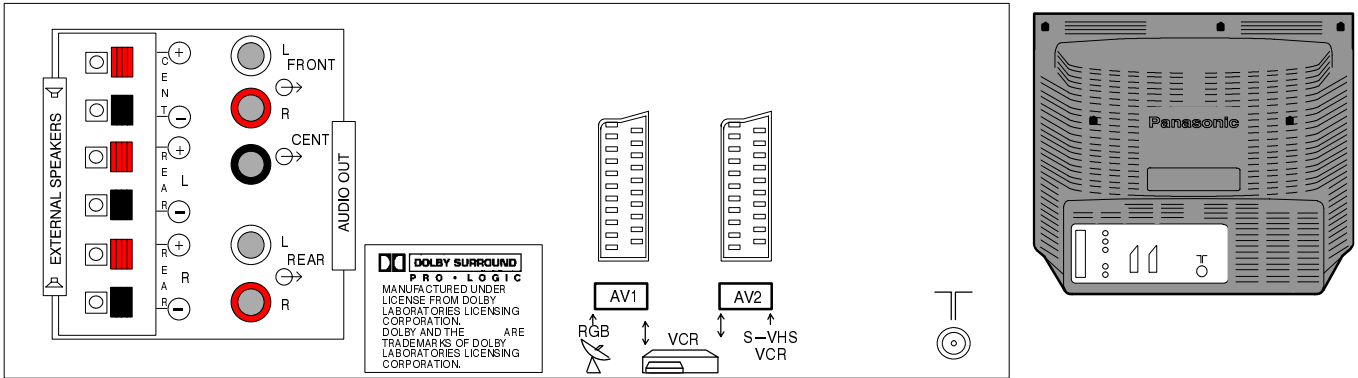

### Notes:

Ancillary equipment and cables shown are not supplied with this TV set.

Do not connect a computer with TTL output (5V) to this set.

The AV2 21 pin terminal can also be used as an Output to Audio / Video Equipment (refer to page 14 for details).

## Audio out using external amplifiers and speakers

The **Audio Out** sockets on the rear of the TV allow you to create your own custom sound output system using additional external amplifiers and speakers. You may decide, for example, to use an external amplifier and speakers for the Front surround output.

Utilising an existing stereo hi-fi system comprising one amplifier, connected to the FRONT DOLBY SURROUND OUT sockets and two speakers to allow separate front left and right channels.



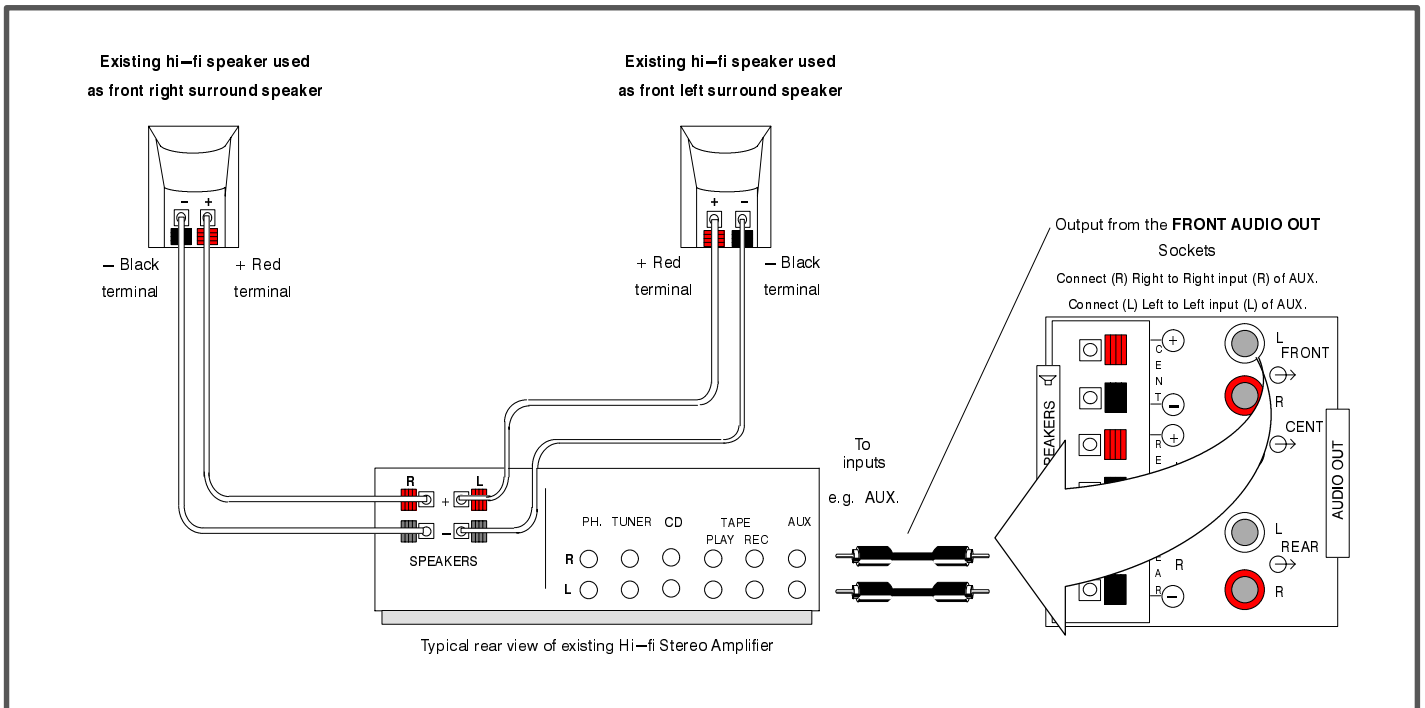
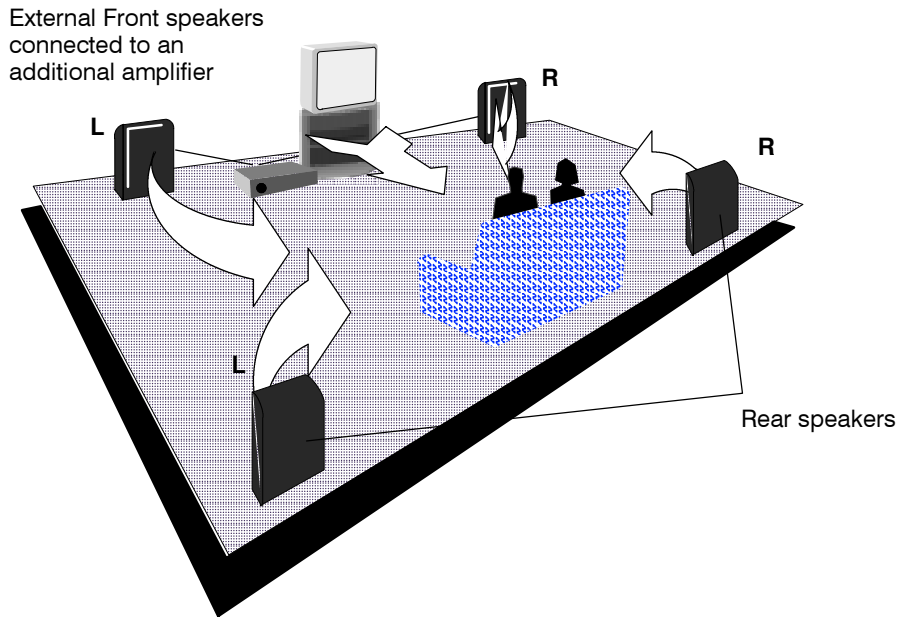





The internal speaker can be switched off in the Surround menu.

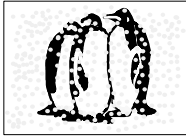
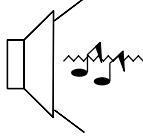

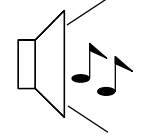
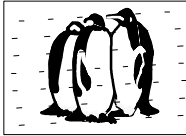
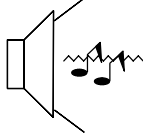
**Notes:**

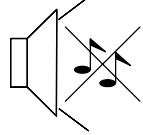
All Audio out sockets can be connected to external amplifiers and speakers if you want to create your own custom system. The level of the signal from the Audio Out sockets is controlled by the TV volume control. The extra equipment required is not supplied.

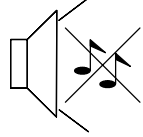
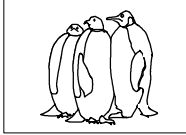
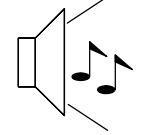
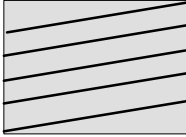
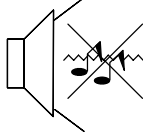
# TROUBLE – SHOOTING

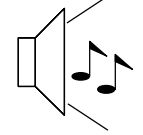
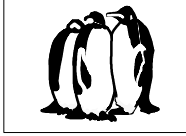
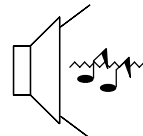
Symptoms		Checks
Picture	Sound	
 <p>Snowy Picture</p>	 <p>Noisy Sound</p>	Aerial location, direction or connection
 <p>Multiple Images</p>	 <p>Normal Sound</p>	Aerial location, direction or connection
 <p>Interference</p>	 <p>Noisy Sound</p>	<p>Electrical appliances Cars / Motorcycles Fluorescent lights</p> <p>Switch on P–NR in Setup menu to reduce picture noise</p>
 <p>Normal Picture</p>	 <p>No Sound</p>	<p>Volume level</p> <p>Sound mute switched on</p>
 <p>No Picture</p>	 <p>No Sound</p>	<p>TV set to AV mode Not plugged into A.C. outlet Not switched on Picture / Sound controls set at minimum levels Check if in standby mode</p>
 <p>No Colour</p>	 <p>Normal Sound</p>	Colour controls set at minimum levels
 <p>Poor or Distorted Picture</p>	 <p>Weak or No Sound</p>	Retune Channel(s)
 <p>Coloured Patches</p>	 <p>Normal Sound</p>	<p>Magnetic Interference from unshielded equipment</p> <p>Receiver moved while switched ON, switch TV off for 30 minutes.</p>
 <p>Normal Picture</p>	 <p>Weak or distorted sound</p>	<p>Sound reception may have deteriorated. Switch Nicam setting (Sound menu) to Off until reception improves.</p>

## FOR YOUR GUIDANCE

### ■ Service

Before requesting service, please refer to the trouble-shooting guide on previous page to determine the symptoms. To obtain service please contact your local Panasonic dealer quoting the model number and serial number (both are located at the rear of the TV).

### ■ TV Games / Home Computers

Extended use of TV games or home computers with any television set can cause a permanent 'shadow' on the screen. This type of irreversible picture tube damage, can be limited by observing the following points:

- Reduce the brightness and contrast levels to a minimum viewing level.
- Do not operate the television set for a continuous period of time while using TV games or home computers.
- This type of picture tube damage, is not an operating defect, and as such is not covered by the Panasonic warranty.

### ■ Sleep Feature

If the set is not switched off when the TV station stops transmitting, it will automatically go to standby mode after 30 minutes. This function will not operate when the TV is in AV mode.

### ■ Last Position Memory

Certain functions have a last position memory, i.e. the setting at the time of switch-off will be the setting used when the receiver is switched on again:–

Programme	Tint (M.NTSC / NTSC only)
3D Bass	
AV Position (if previously set by remote control)	
Flicker reduction	Contrast
Volume	Sharpness
Nicam	Aspect
Bass	Standby
Treble	Artificial Intelligence (AI)
Balance	Colour
AV2 OUT selection	Brightness
Status	Headphone volume
P–NR	Surround mode
Speaker level setting	Speaker distance
Volume correction (in AV mode only)	

## SPECIFICATIONS

		TX–29AD70DP
<b>Power Source</b>		220 – 240V 50Hz A.C.
<b>Power consumption</b>		200W
<b>Standby consumption</b>		1W
<b>Picture Tube</b>		68cm visible diagonal
<b>Audio Output (Music)</b>		Front 20W x 2, Rear 15W x 2, Centre 20W, 3D Bass 25W
<b>Dimensions</b>	H W D	570 mm 698 mm 483 mm
<b>Weight (Kg)</b>		44
<b>Receiving Systems/ Band name</b>	<b>PAL I</b> <b>PAL 525/60</b> <b>M.NTSC</b> <b>NTSC (AV input only)</b>	UHF E21–69 Playback of NTSC tape from PAL Video recorders (VCR) Playback from M.NTSC Videorecorders (VCR) Playback from NTSC Videorecorders (VCR)
<b>Aerial – Rear</b>		UHF
<b>Headphones – Front</b>		3.5mm, impedance 8Ω
<b>AV1 – Rear</b>		21 pin terminal – Audio / Video in / out, RGB in
<b>AV2 – Rear</b>		21 pin terminal – Audio / Video in / out, S–Video in, Selectable output
<b>Dolby Surround Out – Rear</b>		5 x Dolby Surround Out RCA External Speaker connections – 2 x Rear, 1 x Centre
<b>AV3 – Front</b>		S–Video in, 2 x RCA Audio in, 1 x RCA Video in

Specifications are subject to change without notice. Weight and dimensions shown are approximate.

Dolby, Pro Logic and the  are trademarks of Dolby Laboratories

Manufactured under license from Dolby Laboratories Licensing Corporation.

## NOTES







